

CATALOGUE



POWER FACTOR CORRECTION AND CONTROL OF
ELECTRICAL NETWORK QUALITY

INTERNATIONAL VERSION



ALPES TECHNOLOGIES

Contents



+ 2-5 Energy efficiency	Optimum performance and energy efficiency Power Quality audit	2-3 4-5
+ 6-15 General information	Power factor correction Determining the power factor correction solution Selection guide Solutions for all applications	6-7 8-11 12-13 14-15
+ 16-61 Low voltage range	Sub-table of content Alpimatic and Alpistatic automatic capacitor banks Alpivar ³ and Alpican capacitors Catalogue pages	16-17 18-19 20-21 22-61
+ 62-76 High voltage range	Sub-table of content High voltage capacitors High voltage capacitor banks General characteristics of HV components HV capacitor bank faults and protection types External protection devices used with HV capacitors Operating and protection components and devices Installation examples	62-63 64 68 70 71 72 73 74
+ 77-85 Appendices		

Optimum

performance
& energy
efficiency



+ **Alpes Technologies** is a Legrand Group brand specialised in power factor correction and monitoring of electrical Power quality, with a range of products and services to improve the energy efficiency of your installation.



+ **GREEN ECO-TRANSFORMERS**
(100 kVA – 3150 kVA)

Quality and reliability guaranteed, reduction in energy consumption resulting in energy savings.



+ **LV AND HV CAPACITOR BANKS**

Fixed or automatic for power factor correction. Different low or high voltage solutions according to the characteristics of your installation.

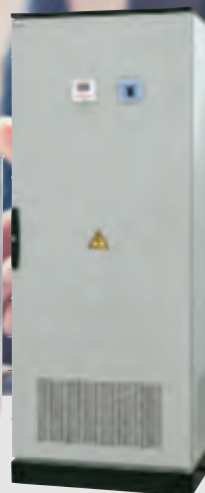

+ **UNINTERRUPTIBLE POWER SUPPLIES (UPS)**

The innovative design and high quality of the components used enable our UPS to achieve up to 96% efficiency, leading to significant energy savings.

+ Refer to the Legrand catalogue

+ See p. 18

+ Refer to the Legrand catalogue

Based around power factor correction, the Alpes Technologies offer is designed to:

IMPROVE POWER AVAILABILITY

- Minimise unwanted interruptions to the power supply and compensate for harmful voltage dips in commercial and industrial environments.
- Optimise the size of your installation.

REDUCE THE MAINTENANCE COSTS OF YOUR ELECTRICAL INSTALLATION

- Deal with harmonics to avoid premature ageing of equipment and destruction of electronic components
- Reduce transformer noise and temperature rise

IMPROVE THE BUILDING'S ENERGY PERFORMANCE

- Optimise energy consumption, by cutting energy bills, energy losses and CO₂ emissions.

Alpes Technologies solutions fit naturally in the Legrand group's global energy efficiency approach which aims to offer ever more solutions for improved management of electricity, reduce consumption and contribute towards supplying high quality energy.

Compensation, improvement, harmonic mitigation... Numerous solutions are available through the various Group brands which can be implemented to guarantee optimum quality of your electricity supply.

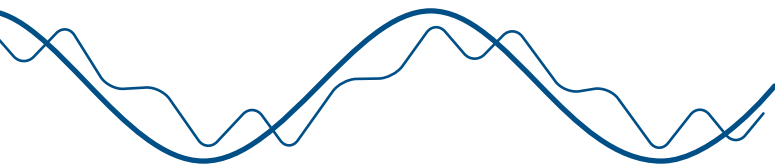

EMDX³ MULTIFUNCTION MEASUREMENT CONTROL UNITS

Active and reactive power, power factor and harmonic level measurements.

+ Refer to the Legrand catalogue

ALPES TECHNOLOGIES: QUALITY AND ENVIRONMENTAL CHALLENGES

- Expenditure devoted to research and development: 8% of annual turnover
- Recognised certifications, issued by the Bureau Veritas: ISO 9001 and ISO 14001
- Low voltage capacitors with patented technology:
 - Vacuum coating technique for capacitor windings
 - Pressure monitoring devices (systems which disconnect the faulty winding)
 - Internal fuses

Power Quality

audit

your electrical network

a key asset in your performance

Would you like an analysis of the quality of your supply to improve energy performance?

Are you faced with a specific problem which requires a dedicated response?

WINNING MANAGEMENT OF YOUR ELECTRICAL NETWORK

The "Power Quality" audit can be used to highlight faults on the supply, determine the size of power factor correction and guide you through the selection of optimised energy supply solutions.

The Alptec2333b portable analyser records important electrical phenomena in your installation, on the main LV distribution board secondary network (230 to 700 V) or via current transformers (for 6 kV, 20 kV, 63 kV HV networks).

The following parameters will be systematically recorded, so we can offer you the best optimisation solutions:

- voltages and currents
- voltage and current harmonics, apparent, active and reactive power
- phase shifts
- voltage dips and overvoltages plus the associated waveforms

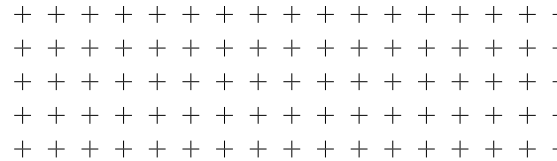

The Alptec 2333b analyser, ideal for existing enclosures.

5 KEY STEPS IN THE POWER QUALITY AUDIT

1 • REQUEST A QUOTATION

- by email to the address com@alpestechnologies.com
- using the online "Request diagnostics" form available on our website www.alpestechnologies.com

2 • QUOTATION

The quotation will be sent to you so you can approve the proposed solution.

Ask Alpes
Technologies to
audit your network:
concrete solutions
guaranteed for
optimum efficiency!



3 • RECEIPT

After approving the quotation, you will receive the Alptec 2333b analyser (IP54, with integrated GSM modem).

4 • INSTALLATION

2 options for ensuring the analyser is correctly installed:

- Remote support using data displayed via GSM
- Intervention by a technician.

5 • REPORT

Handover of a report: measurements with comments and recommendations after 1 week of measurements minimum: real-time simultaneous monitoring of all electrical parameters.



POWER FACTOR CORRECTION

An AC electrical installation incorporating receivers such as transformers, motors, fluorescent tube ballasts or any other receivers whose current is phase-shifted in relation to the voltage, consumes reactive energy.

This reactive energy (expressed in kilovar-hours – kVAh) is billed in the same way as active energy by energy suppliers. Reactive energy therefore results in more power being used and thus contributes to higher electricity bills.

POWER FACTOR

By definition, the power factor of an electrical installation (PF) is equal to the active power P (kW) over the apparent power S (kVA).

$$PF = P \text{ (kW)} / S \text{ (kVA)}$$

Usually $PF \approx \cos \varphi$

a good power factor is:
- high $\cos \varphi$ (close to 1)
- or low $\text{tg } \varphi$ (close to 0)

A power factor of 1 will result in no reactive energy consumption and vice versa.

Energy metering devices record active and reactive energy consumption. Electricity suppliers generally use the term $\text{tg } \varphi$ on their bills.

Cos φ and tg φ are linked by the following equation:

$$\cos \varphi = \frac{1}{\sqrt{1 + (\text{tg } \varphi)^2}}$$

+ Determining the capacitor power in kVAh, see p. 8

ADVANTAGES

By supplying reactive energy on demand, Alpes Technologies capacitor banks allow the subscriber to do the following:

1. Increase the power available to the distribution transformers

EXAMPLE

For a 1000 kVA transformer with $\cos \varphi = 0.75$ and a 750 kW installation: by increasing the $\cos \varphi$ to 0.96 a further 210 kW can be gained (+28%).

Correlation between power factor/gain in available power

Level of power factor $\cos \varphi$	Additional power available to the transformer
0.8	+7%
0.85	+13%
0.9	+20%
0.96	+28%
1	+33%

2. Limit energy losses in the cables by the Joule effect (limiting voltage drops) given the decrease in the current carried in the installation

EXAMPLE

For a 1000 kVA transformer with $\cos \varphi = 0.75$ and a 750 kW installation: by increasing the $\cos \varphi$ to 0.96, we get a reduction in current of around 22%.

3. Achieve energy savings regardless of the type of electricity supplier contract.

- Installing a capacitor bank allows users to:
 - **save energy**
 - **avoid the penalties** applied by the electricity supplier or
 - **optimise the electricity contract**

OPERATING PRINCIPLE

Capacitor banks improve the power factor of an electrical installation by giving it a proportion of the reactive energy it consumes.

The capacitor is a receiver made up of two conductive parts (electrodes) separated by an insulator. When this receiver is subjected to a sinusoidal voltage, it shifts its current, and hence its power (capacitive reactive), by 90° ahead of the voltage.

Conversely, all other receivers (motors, transformers, etc.) shift their reactive component (current or inductive reactive power) by 90° behind the voltage.

The vectorial composition of these currents or reactive powers (inductive and capacitive) gives a reactive resultant current or power below the value which existed before the capacitors were installed.

In simple terms, it is said that inductive receivers (motors, transformers, etc.) consume reactive energy whereas capacitors (capacitive receivers) produce reactive energy.

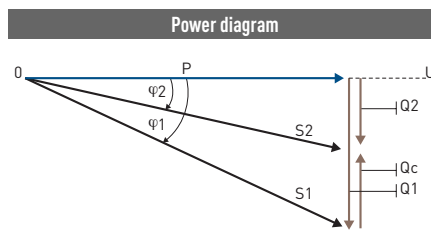

P: Active power
 S1 and S2: apparent powers (before and after compensation)
 Qc: capacitor reactive power
 Q1: reactive power without capacitor
 Q2: reactive power with capacitor

Equations

$$Q2 = Q1 - Qc$$

$$Qc = Q1 - Q2$$

$$Qc = P \cdot \text{tg } \varphi 1 - P \cdot \text{tg } \varphi 2$$

$$\mathbf{Qc = P(\text{tg } \varphi 1 - \text{tg } \varphi 2)}$$

φ 1 phase shift without capacitor
 φ 2 phase shift with capacitor

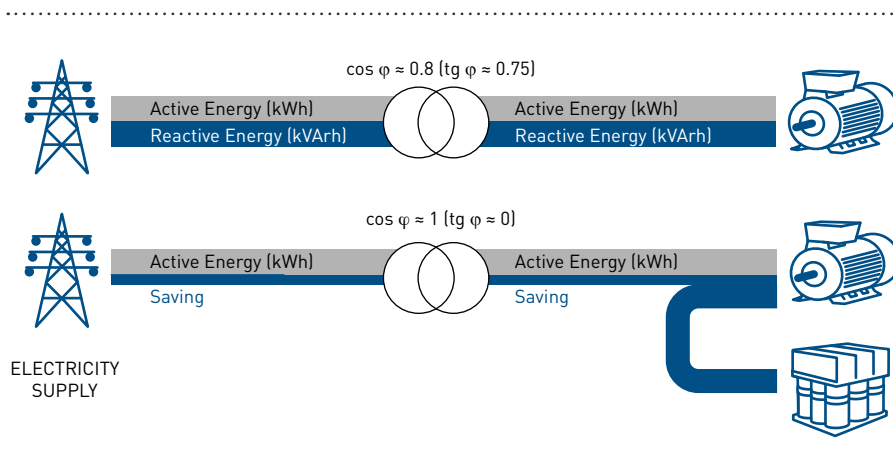

DETERMINING THE LV POWER FACTOR CORRECTION SOLUTION

In a low voltage electrical installation, determining the power factor correction solution requires several stages as follows:

- STEP 1** Determining the capacitor power (kVAR) to compensate for the reactive energy required for the installation
see p.8

- STEP 2** Determining the general configuration
 - ▶ Global compensation for the whole installation
 - ▶ Compensation for each sector
 - ▶ Individual compensation in high power loadssee p.10

- STEP 3** Determining the compensation mode
 - ▶ Fixed compensation for stable load
 - ▶ Automatic compensation for variable or unstable load
 - ▶ Dynamic compensation for very unstable loadsee p.10

- STEP 4** Determining the capacitor bank type according to the level of harmonics
 - ▶ Identify the level of harmonic pollution by Thdi –Thdu measurements or if necessary (eg: new installation) by estimating the percentage of "non-linear loads" (Sh/St)see p.11

 **SELECTION GUIDE**
P. 12-13

STEP 1

DETERMINING THE CAPACITOR POWER IN KVAR

To determine the capacitor power (kVAR) to compensate for the reactive energy required for the installation, use one of the following methods:

- Measurement of the reactive power and Cos φ with measurement control units (such as those in the Legrand EMDX³ range) or with network analysers for complete diagnostics of the various phenomena ("Power Quality" Audit, see p. 4).
- Analysis of the electricity supplier's bills according to the subscription type (subscribed demand, reactive energy billed in kVARh and tg φ).
- In the context of future installations, compensation is frequently required right from the commissioning stage. In this case, it is not possible to calculate the capacitor bank using conventional methods (electricity bill).

For this type of installation, we recommend installing a capacitor bank with approximately **25% of the nominal power of the corresponding HV/LV transformer.**

EXAMPLE

1000 kVA transformer, capacitor Q = 250 kVAR
 NB: This type of ratio corresponds to the following operating conditions:
 - 1000 kVA transformer
 - Actual transformer load = 75%
 - Cos φ of the load = 0.80 } $k = 0.421$
 - Cos φ to be obtained = 0.95 } (see table on opposite page)

$Q_c = 1000 \times 75\% \times 0.80 \times 0.421 = 250 \text{ kvar}$

- Estimated total amount of reactive energy needed for all receivers in the installation, especially motors and transformers depending on the manufacturer's data.

Initial power factor		Capacitor power to be installed, in kvar per kW of load, to increase the power factor to $\cos \varphi_2$:											
$\cos \varphi_1$	$\text{tg } \varphi_1$	$\cos \varphi_2$:											
		0.90	0.91	0.92	0.93	0.94	0.95	0.96	0.97	0.98	0.99	1	
		$\text{tg } \varphi_2$:	0.48	0.46	0.43	0.40	0.36	0.33	0.29	0.25	0.20	0.14	0.0
0.40	2.29		1.805	1.832	1.861	1.895	1.924	1.959	1.998	2.037	2.085	2.146	2.288
0.41	2.22		1.742	1.769	1.798	1.831	1.840	1.896	1.935	1.973	2.021	2.082	2.225
0.42	2.16		1.681	1.709	1.738	1.771	1.800	1.836	1.874	1.913	1.961	2.002	2.164
0.43	2.10		1.624	1.651	1.680	1.713	1.742	1.778	1.816	1.855	1.903	1.964	2.107
0.44	2.04		1.558	1.585	1.614	1.647	1.677	1.712	1.751	1.790	1.837	1.899	2.041
0.45	1.98		1.501	1.532	1.561	1.592	1.626	1.659	1.695	1.737	1.784	1.846	1.988
0.46	1.93		1.446	1.473	1.502	1.533	1.567	1.600	1.636	1.677	1.725	1.786	1.929
0.47	1.88		1.397	1.425	1.454	1.485	1.519	1.532	1.588	1.629	1.677	1.758	1.881
0.48	1.83		1.343	1.370	1.400	1.430	1.464	1.467	1.534	1.575	1.623	1.684	1.826
0.49	1.78		1.297	1.326	1.355	1.386	1.420	1.453	1.489	1.530	1.578	1.639	1.782
0.50	1.73		1.248	1.276	1.303	1.337	1.369	1.403	1.441	1.481	1.529	1.590	1.732
0.51	1.69		1.202	1.230	1.257	1.291	1.323	1.357	1.395	1.435	1.483	1.544	1.686
0.52	1.64		1.160	1.188	1.215	1.249	1.281	1.315	1.353	1.393	1.441	1.502	1.644
0.53	1.60		1.116	1.144	1.171	1.205	1.237	1.271	1.309	1.349	1.397	1.458	1.600
0.54	1.56		1.075	1.103	1.130	1.164	1.196	1.230	1.268	1.308	1.356	1.417	1.559
0.55	1.52		1.035	1.063	1.090	1.124	1.156	1.190	1.228	1.268	1.316	1.377	1.519
0.56	1.48		0.996	1.024	1.051	1.085	1.117	1.151	1.189	1.229	1.277	1.338	1.480
0.57	1.44		0.958	0.986	1.013	1.047	1.079	1.113	1.151	1.191	1.239	1.300	1.442
0.58	1.40		0.921	0.949	0.976	1.010	1.042	1.073	1.114	1.154	1.202	1.263	1.405
0.59	1.37		0.884	0.912	0.939	0.973	1.005	1.039	1.077	1.117	1.165	1.226	1.368
0.60	1.33		0.849	0.878	0.905	0.939	0.971	1.005	1.043	1.083	1.131	1.192	1.334
0.61	1.30		0.815	0.843	0.870	0.904	0.936	0.970	1.008	1.048	1.096	1.157	1.299
0.62	1.27		0.781	0.809	0.836	0.870	0.902	0.936	0.974	1.014	1.062	1.123	1.265
0.63	1.23		0.749	0.777	0.804	0.838	0.870	0.904	0.942	0.982	1.030	1.091	1.233
0.64	1.20		0.716	0.744	0.771	0.805	0.837	0.871	0.909	0.949	0.997	1.058	1.200
0.65	1.17		0.685	0.713	0.740	0.774	0.806	0.840	0.878	0.918	0.966	1.007	1.169
0.66	1.14		0.654	0.682	0.709	0.743	0.775	0.809	0.847	0.887	0.935	0.996	1.138
0.67	1.11		0.624	0.652	0.679	0.713	0.745	0.779	0.817	0.857	0.905	0.966	1.108
0.68	1.08		0.595	0.623	0.650	0.684	0.716	0.750	0.788	0.828	0.876	0.937	1.079
0.69	1.05		0.565	0.593	0.620	0.654	0.686	0.720	0.758	0.798	0.840	0.907	1.049
0.70	1.02		0.536	0.564	0.591	0.625	0.657	0.691	0.729	0.796	0.811	0.878	1.020
0.71	0.99		0.508	0.536	0.563	0.597	0.629	0.663	0.701	0.741	0.783	0.850	0.992
0.72	0.96		0.479	0.507	0.534	0.568	0.600	0.634	0.672	0.721	0.754	0.821	0.963
0.73	0.94		0.452	0.480	0.507	0.541	0.573	0.607	0.645	0.685	0.727	0.794	0.936
0.74	0.91		0.425	0.453	0.480	0.514	0.546	0.580	0.618	0.658	0.700	0.767	0.909
0.75	0.88		0.398	0.426	0.453	0.487	0.519	0.553	0.591	0.631	0.673	0.740	0.882
0.76	0.86		0.371	0.399	0.426	0.460	0.492	0.526	0.564	0.604	0.652	0.713	0.855
0.77	0.83		0.345	0.373	0.400	0.434	0.466	0.500	0.538	0.578	0.620	0.687	0.829
0.78	0.80		0.319	0.347	0.374	0.408	0.440	0.474	0.512	0.552	0.594	0.661	0.803
0.79	0.78		0.292	0.320	0.347	0.381	0.413	0.447	0.485	0.525	0.567	0.634	0.776
0.80	0.75		0.266	0.294	0.321	0.355	0.387	0.421	0.459	0.499	0.541	0.608	0.750
0.81	0.72		0.240	0.268	0.295	0.329	0.361	0.395	0.433	0.473	0.515	0.582	0.724
0.82	0.70		0.214	0.242	0.269	0.303	0.335	0.369	0.407	0.447	0.489	0.556	0.698
0.83	0.67		0.188	0.216	0.243	0.277	0.309	0.343	0.381	0.421	0.463	0.530	0.672
0.84	0.65		0.162	0.190	0.217	0.251	0.283	0.317	0.355	0.395	0.437	0.504	0.645
0.85	0.62		0.136	0.164	0.191	0.225	0.257	0.291	0.329	0.369	0.417	0.478	0.602
0.86	0.59		0.109	0.140	0.167	0.198	0.230	0.264	0.301	0.343	0.390	0.450	0.593
0.87	0.57		0.083	0.114	0.141	0.172	0.204	0.238	0.275	0.317	0.364	0.424	0.567
0.88	0.54		0.054	0.085	0.112	0.143	0.175	0.209	0.246	0.288	0.335	0.395	0.538
0.89	0.51		0.028	0.059	0.086	0.117	0.149	0.183	0.230	0.262	0.309	0.369	0.512
0.90	0.48			0.031	0.058	0.089	0.121	0.155	0.192	0.234	0.281	0.341	0.484

The table opposite can be used to calculate the capacitor power in order to switch from an initial power factor to a desired power factor based on the receiver power in kW. It also gives the equivalence between $\cos \varphi$ and $\text{tg } \varphi$.

For example: 200 kW motor - $\cos \varphi_1 = 0.75$ - $\cos \varphi_2$ desired = 0.93 - $Q_c = 200 \times 0.487 = 98 \text{ kVAr}$

DETERMINING THE POWER FACTOR CORRECTION SOLUTION (continued)

STEP 2

DETERMINING THE GENERAL CONFIGURATION

Depending on the installation architecture, the location and power of the receivers consuming reactive energy, the following are possible:

GLOBAL COMPENSATION in the main LV distribution board > choose an automatic or dynamic bank (Alpimatic or Alpistatic)

COMPENSATION BY EACH SECTOR in the secondary distribution boards, for example: workshop secondary distribution board > choose an automatic or dynamic bank (Alpimatic or Alpistatic)

INDIVIDUAL COMPENSATION as close as possible to the load consuming the reactive energy (depending on variation in the loads a fixed bank, Alpivar³ or Alpi bloc, may suffice).

EXAMPLE

Compensating reactive energy at the terminals of a motor by a fixed capacitor bank controlled at the same time as the motor

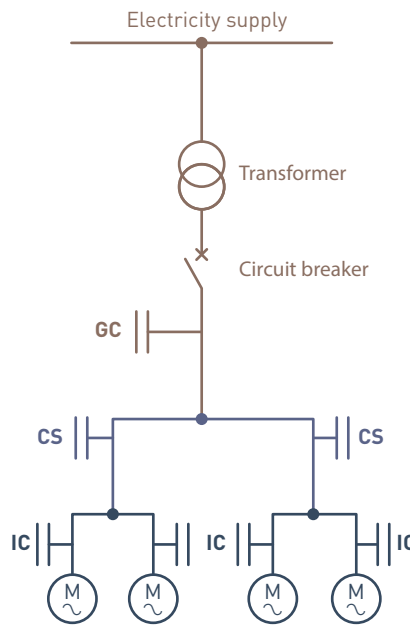

GC = Global compensation
 CS = Compensation by sector
 IC = Individual compensation
 M = Typical motor load

STEP 3

DETERMINING THE COMPENSATION MODE

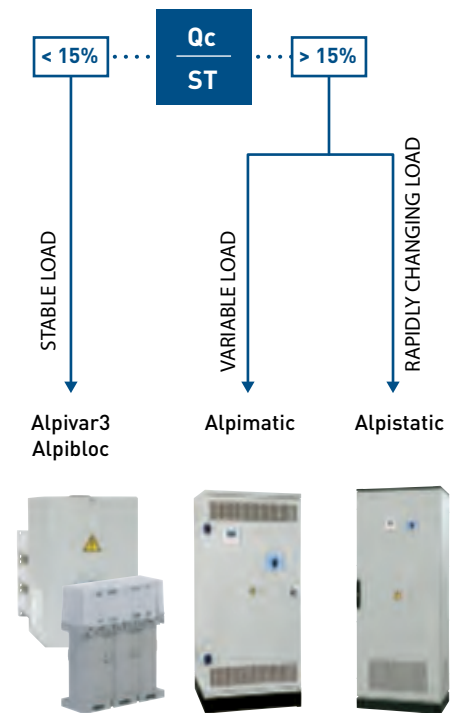

QC = Power of the compensation system in kVar
 ST = Power of the MV/LV transformer in kVA (or MV/LV transformers if there are two or more transformers in parallel)

	GLOBAL COMPENSATION	COMPENSATION BY EACH SECTOR	INDIVIDUAL COMPENSATION
ADVANTAGES	<ul style="list-style-type: none"> ▶ No billing of reactive energy ▶ Increased power available at the transformer secondary ▶ Most economical solution 	<ul style="list-style-type: none"> ▶ No billing of reactive energy ▶ Reduction of losses along the line between transformer and mains secondary distribution boards ▶ Economical solution 	<ul style="list-style-type: none"> ▶ No billing of reactive energy ▶ Reduction of losses along the whole line between transformer and the load ▶ Power factor correction as close as possible to the devices consuming reactive energy
COMMENTS	<ul style="list-style-type: none"> ▶ No reduction in losses along the line (voltage dips for loads a long way from the capacitor bank) ▶ No savings in terms of sizing electrical equipment 	<ul style="list-style-type: none"> ▶ Solution generally used for very extensive factory networks 	<ul style="list-style-type: none"> ▶ Most expensive solution given the high number of installations

STEP 4

DETERMINING THE CAPACITOR BANK TYPE ACCORDING TO THE LEVEL OF HARMONICS

For supplies with a high level of harmonic pollution, Alpes Technologies recommends capacitor banks with SAH, SAH reinforced and SAH extra-reinforced type detuned reactors.

The detuned reactor performs a threefold role:



- Increasing the capacitor impedance in relation to the harmonic currents
- Shifting the parallel resonance frequency (Fr.p) of the source and capacitor to below the main

frequencies of the harmonic currents that are causing interference.

Tuning frequency (Hz)	Blocking factor (P%)	Tuning number (n)
215	5.4	4.3
189	7	3.78
135	14	2.7

- Helping to reduce harmonic levels in the supply.

The table opposite can be used to select the capacitor bank type according to the degree of harmonic pollution, by measuring the percentage of THDi and THDu or by estimating the percentage total power of SH/ST non-linear loads.

Measurements		Estimates	Type of capacitor to be used	
THDU %	THDi %	SH/ST %		
≤ 3	≤ 10	≤ 15	S type	
≤ 4	≤ 15	≤ 25	H type	
≤ 6	≤ 30	≤ 35	SAH type ⁽¹⁾⁽²⁾	Reactor tuned to 189 Hz Reactor tuned to 135 Hz if high level of 3rd order harmonics
≤ 8	≤ 40	≤ 50	SAH Reinforced type ⁽¹⁾	Reactor tuned to 189 Hz
≤ 11	≤ 55	≤ 65	SAH Extra-reinforced type ⁽¹⁾ OR Active filter	Installation audit required, please consult us Power Quality audit (p. 4) Reactor tuned to 215 Hz
> 11	> 55	> 65	Active filter	Installation audit required, please consult us Power Quality audit (p. 4)

ST: power in kVA of the MV/LV transformer (or MV/LV transformers if there are two or more transformers in parallel).

SH: expanded power in kVA of the harmonic generators in the secondary of the MV/LV transformer(s) to be compensated.

THDi: percentage of total harmonic current pollution.

THDu: percentage of total harmonic voltage pollution.

(1) SAH, SAH reinforced and SAH extra-reinforced type capacitor banks are enclosures with detuned reactor. Check compatibility with your local operator's centralised remote control frequency. For other tuning frequencies please consult us.

(2) SAH type capacitor banks with 135 Hz reactor are recommended for an installation with high level of 3rd order harmonics, for example if $I_{h3} > 0.2 \cdot I_{h5}$.
Ih3: 3rd order harmonic currents
Ih5: 5th order harmonic currents

Selection guide

determining the reactive energy compensation solution

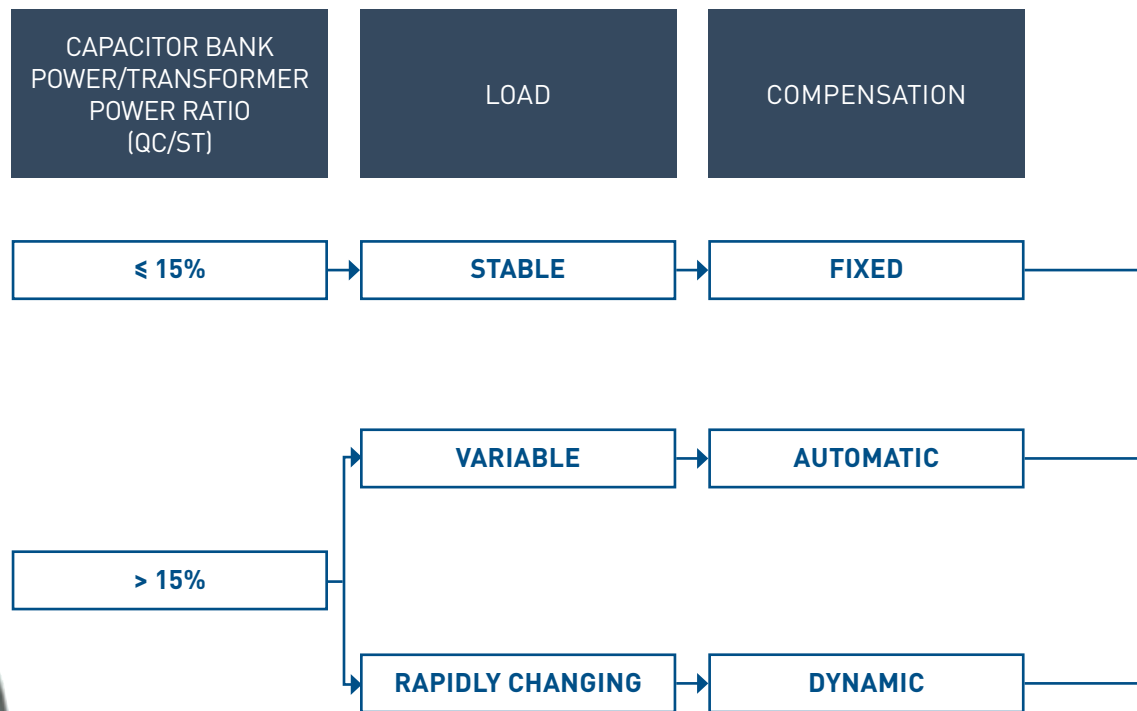

ALPIVAR³ (p. 36)



ALPIBLOC (p. 22)

ALPES TECHNOLOGIES RANGES	HARMONIC POLLUTION LEVEL				
	MEASUREMENTS		ESTIMATES	TYPE OF CAPACITOR TO BE USED	
	THDU %	THDI %	SH/ST %		
WITHOUT CIRCUIT-BREAKER ALPIVAR³ p. 36	WITH CIRCUIT-BREAKER ALPIBLOC p. 22	≤ 3	≤ 10	≤ 15	S type
		≤ 4	≤ 15	≤ 25	H type
		≤ 6	≤ 30	≤ 35	SAH type⁽²⁾ 189 Hz reactor 135 Hz reactor ⁽³⁾
WITH/WITHOUT CIRCUIT-BREAKER ALPIMATIC p. 24-27		≤ 8	≤ 40	≤ 50	SAH Reinforced type⁽²⁾ 189 Hz reactor
					SAH Extra-reinforced type⁽²⁾ 215 Hz reactor
WITH/WITHOUT CIRCUIT-BREAKER ALPISTATIC⁽¹⁾ p. 31-33		≤ 11 ⁽⁴⁾	≤ 55 ⁽⁴⁾	≤ 65 ⁽⁴⁾	Active filter

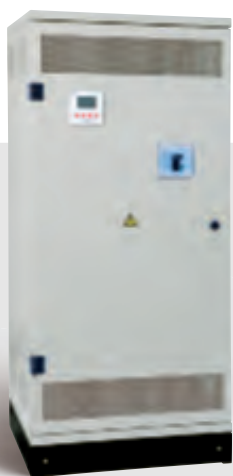

ALPIMATIC (p. 24-27)

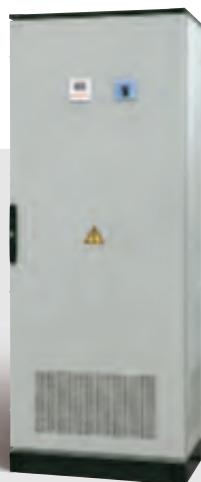

ALPISTATIC (p. 31-33)

[1] The AlpiSTATIC range is only available in a version with detuned reactor.

[2] SAH, SAH reinforced and SAH extra-reinforced type capacitor banks are enclosures with detuned reactor. Check compatibility with your local operator's centralised remote control frequency. For other tuning frequencies please consult us.

[3] SAH type capacitor banks with 135 Hz reactor are recommended for an installation with high level 3rd order harmonics.

[4] From this harmonic level, an audit of the installation should be made to determine the size of the adapted power factor correction solution and/or treatment of harmonics with active filter. Please consult us.

Solutions for all applications

+ Alpes Technologies offers solutions for power factor correction that are perfectly suited to different types of application⁽¹⁾



⁽¹⁾ These equivalences are given for information purposes only. Power factor correction solutions must be chosen according to the actual characteristics of the installation site.



ALPIBLOC

S and H types



ALPIMATIC

S and H types



ALPIMATIC

H and SAH types

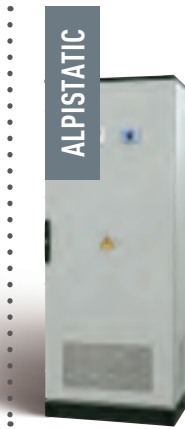

ALPISTATIC

H and SAH types



ALPIMATIC

SAH reinforced and SAH extra-reinforced types

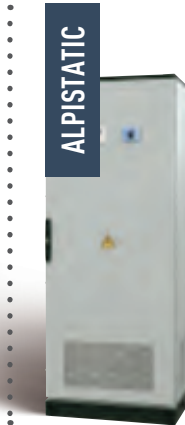

ALPISTATIC

SAH, SAH reinforced and SAH extra-reinforced types



HV BANKS



LOW VOLTAGE RANGE

Fixed and automatic capacitor banks



P. 22
Alpibloc fixed capacitor banks with integrated circuit breaker

Components for low voltage power factor correction



P. 36
Alpivar³ capacitor banks

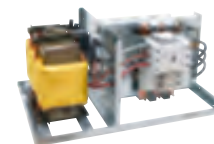

P. 55
Alpimatic racks with SAH, SAH reinforced and SAH extra-reinforced type detuned reactor

SEE THE PRODUCTS



Alpimatic automatic capacitor banks with or without detuned reactor (p. 18 and 24 to 30)



Alpistatic automatic capacitor banks with detuned reactor (p. 19 and 31 to 33)



P. 24
Alpimatic,
S and H types



P. 26
Alpimatic with SAH,
SAH reinforced and
SAH extra-reinforced
type detuned reactor



P. 31
Alpimatic with SAH,
SAH reinforced and
SAH extra-reinforced
type detuned reactor



P. 45
Alpican
capacitors



P. 53
Detuned reactors

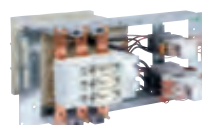

P. 54
Alpimatic racks,
S and H types



P. 56
Alpimatic racks with
SAH, SAH reinforced
and SAH extra-
reinforced type
detuned reactor



P. 57
Alptec power factor
controllers



P. 58
CT current
transformers



Alpivar³
capacitor banks
S and H types from
2.5 to 125 kVAr
(p. 20 and 36)

AUTOMATIC CAPACITOR BANKS

Alpimatic

Alpimatic capacitor banks are automatic banks with switching via electromechanical contactors.

RACK COMPOSITION

- S and H types for M and MH ranges
 - SAH, SAH reinforced and SAH extra-reinforced types for the MS ranges
- These are controlled by a power factor controller and integrated in an enclosure. Available in 2 versions: with or without circuit breaker

GENERAL CHARACTERISTICS

- IP 30 - IK 10 cabinet or enclosure
- Standard: IEC 61921
- Temperature class:
 - Operation -10/+45°C (average over 24 hours : 40°C)
 - Storage -30/+60°C
- Ventilation: natural or forced (for enclosures with detuned reactor)
- Colour: RAL 7035 grey enclosure

SPECIFIC CHARACTERISTICS

- Fully modular design for easy extension and maintenance
- Power factor controller with easy commissioning
- Extendable enclosure on request

ELECTRICAL CHARACTERISTICS

- Built-in power supply for auxiliary circuits
- Integrated connector block for load shedding contact (generator set, specific electricity tariffs, etc.)
- Possible remote alarm feedback

OPTIONS

- Smoke detection
- Air conditioning
- IP 54
- Fixed step
- Summing current transformer

CONNECTION (to be provided)

- Power cables in accordance with table on p. 46
- A current transformer to be positioned on phase L1 of the installation upstream of all the receivers and the capacitor bank
 - primary: adapted to the installation
 - secondary: 5 A
 - power: 10 VA (recommended) - Class 1

 The current transformer can be supplied separately on request.

 Alpibloc fixed capacitor banks with integrated circuit breaker, see p. 22



Alpistatic

Alpistatic capacitor banks are automatic banks with switching via thyristor-controlled solid state contactors.

They provide "soft, fast" power factor correction suitable for receivers that are sensitive to voltage variations (PLCs, industrial computers) or that have ultra-fast cycles (robots, welding machines, variable speed drives).



COMPOSITION

- The capacitor part, subdivided into a number of steps depending on the power rating of the capacitor
- One three-pole solid state contactor per step (breaking all three phases)
- Cooling of each solid state contactor by fan-cooled heat sink
- SAH, SAH reinforced and SAH extra-reinforced types: 1 three-phase detuned reactor protecting the solid state contactor and providing protection against harmonics
- One set of 3 HRC fuses per step
- A system for controlling the solid state contactors, including a reactive energy controller for automatic control: with "auto-man" operation:
 - Front panel display showing the number of steps in operation and the installation $\cos \varphi$
 - Display of a number of other parameters (harmonics, etc.).
- A system for controlling the solid state contactors, including a microprocessor instrumentation and control card for each solid state contactor, that:
 - activates and deactivates the solid state contactors within 40 ms max.
 - avoids any transient voltage and current phenomena when steps are activated or deactivated
- Available in 2 versions: with or without circuit breaker

GENERAL CHARACTERISTICS

- IP 30 - IK 10 enclosure
- Standard: IEC 61921
- Temperature class:
 - Operation -10/+ 45°C (average over 24 hours : 40°C)
 - Storage - 30/+ 60°C
- Ventilation: forced
- Cable entry via the bottom (or via the top on request)

ELECTRICAL CHARACTERISTICS

- Built-in power supply for auxiliary circuits
- Connector block for built-in load-shedding contact

OPTIONS

- Smoke detection
- Air conditioning
- IP 54
- Fixed step
- Summing current transformer

CONNECTION (to be provided)

- Power cables in accordance with table on page 46
- A current transformer to be positioned on phase L3 of the installation upstream of all the receivers and the capacitor bank:
 - primary: adapted to the installation
 - secondary: 5 A
 - power: 10 VA (recommended) - Class 1

	SENSITIVE DATA	ALPISTATIC	CONVENTIONAL SYSTEM WITH ELECTROMECHANICAL CONTACTORS
Presence of electromechanical contactors		no	yes
Wear of moving parts		no	yes
Contact bounce phenomenon		no	possible
Contact fatigue		zero	high
Transient overcurrents (deactivation of steps)		no	yes (may exceed 200 ln)
Transient undervoltages		none	yes (up to 100%)
Compatibility (PLCs, computer equipment, etc.)		excellent	average
Compatibility (welding machines, generator sets, etc.)		excellent	poor
Response time (activation and deactivation)		40 milliseconds max.	approx. 30 seconds
Number of operations		unlimited	limited (electromechanical contactor)
Sound level during operation		none	low (electromechanical contactor)
Reduction of FLICKER	yes (for highly inductive loads)		no
Creation of harmonics		no	no

CAPACITORS

Alpivar³

Alpivar³ patented capacitors with vacuum technology are totally dry units with no impregnation or insulation liquid.

ADVANTAGES OF THE RANGE

Alpivar³ capacitors are designed by combining individual single-phase windings, connected in a delta configuration to produce a three-phase unit.

These windings are created using two metallised polypropylene films with zinc coating on one side:

- The metal coating forms the electrode
- The polypropylene film forms the insulation

They are then vacuum-coated with a self-extinguishing thermosetting polyurethane resin which forms the casing, providing mechanical and electrical environmental protection.

This vacuum coating technique for the windings, which is unique to ALPES TECHNOLOGIES, gives Alpivar³ capacitors excellent resistance over time and a much longer service life than conventional units.

Vacuum sealing ensures that there is no air or moisture near the windings. This design provides excellent resistance to overvoltages and partial discharges.

This unit complies fully with environmental protection requirements (PCB-free).

PRESENTATION

Monobloc or modular, the Alpivar³ capacitor meets all user requirements.

The modular solution in particular, with its quick, easy assembly, can be used to create units with different power ratings, resulting in a significant reduction in storage costs for integrators and local distributors.

Conforming to standard IEC 60831-1 and 2.

INSTALLATION

Its compact form makes it easy to install and significantly reduces the costs of enclosures and racks.

The casing is particularly resistant to all solvents and atmospheric agents (rain, sun, salty air, etc.).

The Alpivar³ capacitor is ideal for installations:

- In corrosive atmospheres
- Outdoors (on request)

CONNECTION

- The easy accessibility of the terminals on the top of the unit make the Alpivar³ capacitor very easy to connect.
- The use of a system of "socket" terminals enables direct connection of the unit via cables and lugs.
- The Alpivar³ double-insulated or class 2 capacitor does not need earthing.

MOUNTING POSITION

- **Vertical or horizontal mounting.**



ELECTRICAL PROTECTION DEVICES

• **Self-healing dielectric:** this property is connected with the characteristics of the metal deposit which forms the electrode and the nature of the insulating medium (polypropylene film). This special manufacturing technique prevents breakdown of the capacitor due to electrical overvoltages. Such overvoltages pierce the dielectric and cause discharges which vaporise the metal near the short-circuit, thus instantaneously restoring the electrical insulation.

• **Internal fuses:** one per winding.

• **Pressure monitoring devices:** if an electrical fault cannot be overcome by the film self-healing or by means of the electrical fuse, gas is emitted, causing a membrane to deform and disconnecting the faulty winding. Triggering of the pressure monitoring devices is visible from outside the capacitor. This feature makes it easy to quickly check the status of the unit.

👍 These three protection devices, together with the vacuum coating on the windings (technique patented by ALPES TECHNOLOGIES), result in a very high-tech unit.

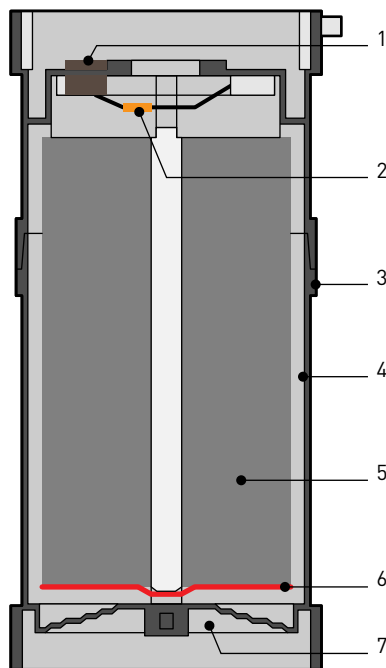

- 1 – Socket terminals for direct connection via cables and lugs
- 2 – Internal discharge resistor
- 3 – Self-extinguishing plastic casing
- 4 – Self-healing coil
- 5 – Resin under vacuum
- 6 – Electrical fuse
- 7 – Pressure monitoring devices with visible trip indication

Alpican

SAFE RELIABLE & EASY TO INSTALL ALUMINIUM CAN CAPACITORS

Alpican is constructed with three single elements stacked and assembled to form a delta connection.

- Conforms to IEC 60831-1 and 2
- Compact design in cylindrical aluminium can for uniform heat dissipation
- Biodegradable soft resin impregnant
- Dual safety with self healing and overpressure disconnecter
- Range: 2.5 to 30 kVAr - 50 HZ (3 to 36 kVAr - 60 Hz).





Alpibloc fixed capacitor banks with integrated circuit breaker

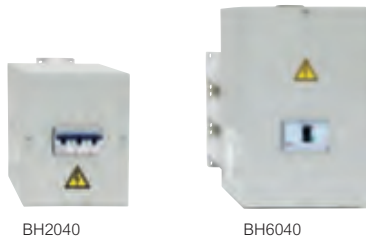

Technical characteristics **opposite**

400 V - 50 Hz three-phase network
 Alpibloc is an Alpivar³ capacitor with integrated circuit breaker
 Equipment supplied ready for connection, for fixed compensation of low and medium power electrical devices
 For certain applications (remote control, etc.) the circuit breaker can be replaced by a contactor and HRC fuses
 Conforming to standard IEC 61921

Pack	Cat.Nos	S type		
		Max. harmonic pollution level		
		THDU ≤ 3%, THDI ≤ 10%		
		Nominal power (kVAr)	Circuit breaker rating	Breaking capacity
1	B1040	10	20 A	50 kA
1	B1540	15	32 A	50 kA
1	B2040	20	40 A	50 kA
1	B2540	25	50 A	50 kA
1	B3040	30	63 A	50 kA
1	B4040	40	100 A	25 kA
1	B5040	50	100 A	25 kA
1	B6040	60	125 A	25 kA
1	B7540	75	160 A	25 kA
1	B9040	90	250 A	36 kA
1	B10040	100	250 A	36 kA
1	B12540	125	250 A	36 kA
1	B15040	150	400 A	36 kA
1	B17540	175	400 A	36 kA

Pack	Cat.Nos	H type		
		Max. harmonic pollution level		
		THDU ≤ 4%, THDI ≤ 15%		
		Nominal power (kVAr)	Circuit breaker rating	Breaking capacity
1	BH1040	10	20 A	50 kA
1	BH1540	15	32 A	50 kA
1	BH2040	20	40 A	50 kA
1	BH2540	25	50 A	50 kA
1	BH3040	30	63 A	50 kA
1	BH4040	40	100 A	25 kA
1	BH5040	50	100 A	25 kA
1	BH6040	60	125 A	25 kA
1	BH7540	75	160 A	25 kA
1	BH9040	90	250 A	36 kA
1	BH10040	100	250 A	36 kA
1	BH12540	125	250 A	36 kA
1	BH15040	150	400 A	36 kA
1	BH17540	175	400 A	36 kA

Pack	Cat.Nos	Fixing accessory
1	SUPP/ALPIBLOC	Wall-mount bracket for S and H type Alpibloc up to 60 kVAr

Alpibloc fixed capacitor banks with integrated circuit breaker and detuned reactor



BS.R12040.189

Technical characteristics **opposite**

400 V - 50 Hz three-phase network
 Alpivar³ capacitor combined with a detuned reactor and a circuit breaker
 Assembly fitted and wired in enclosure
 IP 30 - IK 10 enclosure
 Conforming to standard IEC 61921

Pack	Cat.Nos	SAH type		
		Max. harmonic pollution level		
		THDU ≤ 6%, THDI ≤ 30%		
		189 Hz (p = 7%)		
		Nominal power (kVAr)	Circuit breaker rating	Breaking capacity
1	BS5040.189	50	125 A	25 kA
1	BS7540.189	75	250 A	36 kA
1	BS10040.189	100	250 A	36 kA
1	BS15040.189	150	400 A	36 kA
1	BS20040.189	200	630 A	36 kA
1	BS25040.189	250	630 A	36 kA
1	BS30040.189	300	630 A	36 kA

Pack	Cat.Nos	SAH reinforced type		
		Max. harmonic pollution level		
		THDU ≤ 8%, THDI ≤ 40%		
		189 Hz (p = 7%)		
		Nominal power (kVAr)	Circuit breaker rating	Breaking capacity
1	BS.R4040.189	40	125 A	25 kA
1	BS.R8040.189	80	250 A	36 kA
1	BS.R12040.189	120	400 A	36 kA
1	BS.R16040.189	160	400 A	36 kA
1	BS.R20040.189	200	630 A	36 kA
1	BS.R24040.189	250	630 A	36 kA
1	BS.R28040.189	280	630 A	36 kA

Pack	Cat.Nos	SAH extra-reinforced type		
		Max. harmonic pollution level		
		THDU ≤ 11%, THDI ≤ 55%		
		215 Hz (p = 5.4%)		
		At this level of harmonic pollution, we strongly recommend that you contact us to take measurements on site		
		Nominal power (kVAr)	Circuit breaker rating	Breaking capacity
1	BS.RS7240.215	72	250 A	36 kA
1	BS.RS14440.215	144	400 A	36 kA
1	BS.RS21640.215	216	630 A	36 kA
1	BS.RS28840.215	288	1250 A	50 kA

Alpibloc fixed capacitor banks with integrated circuit breaker

Alpibloc fixed capacitor banks with integrated circuit breaker and detuned reactor

■ Dimensions

S and H type

Cat.Nos	Dimensions (mm)			Weight (kg)	Enclosure
	A	B	C		
B1040 BH1040	380	190	230	8	BL type
B1540 BH1540	380	190	230	8	BL type
B2040 BH2040	380	190	230	8	BL type
B2540 BH2540	380	190	230	8	BL type
B3040 BH3040	380	190	230	12	BL type
B4040 BH4040	380	365	230	20	BL type
B5040 BH5040	380	365	230	20	BL type
B6040 BH6040	380	365	230	24	BL type
B7540 BH7540	380	365	230	24	BL type
B9040 BH9040	380	540	230	37	BL type
B10040 BH10040	380	540	230	37	BL type
B12540 BH12540	380	540	230	40	BL type
B15040 BH15040	1400	600	500	53	PL2-F type
B17540 BH17540	1400	600	500	56	PL2-F type

BL type enclosure

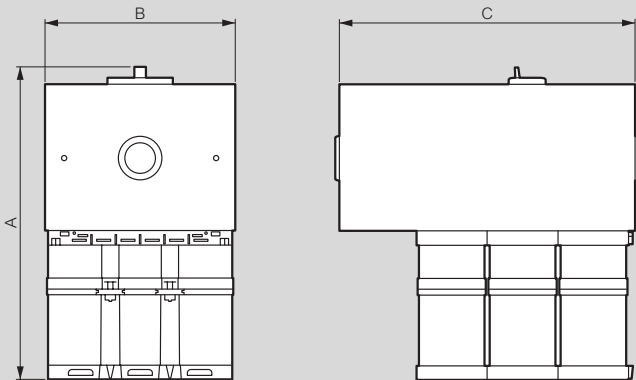

PL2-F type enclosure (natural ventilation)

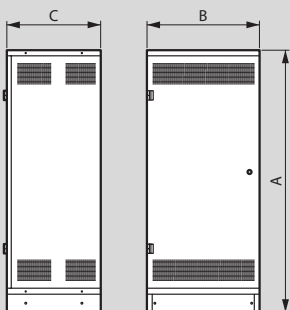

■ Dimensions

SAH type with circuit breaker - 189 Hz ($p = 7\%$)

Cat.Nos	Dimensions (mm)			Weight (kg)	Enclosure
	A	B	C		
BS5040.189	1400	600	500	118	PL2-F
BS7540.189	1400	600	500	124	PL2-F
BS10040.189	1400	600	500	130	PL2-F
BS15040.189	2100	800	500	170	AL-F
BS20040.189	2100	800	500	266	AL-F
BS25040.189	2100	800	500	307	AL-F
BS30040.189	2100	800	500	325	AL-F

SAH reinforced type with circuit breaker - 189 Hz ($p = 7\%$)

Cat.Nos	Dimensions (mm)			Weight (kg)	Enclosure
	A	B	C		
BS.R4040.189	1400	600	500	97	PL2-F
BS.R8040.189	1400	600	500	144	PL2-F
BS.R12040.189	1400	600	500	191	PL2-F
BS.R16040.189	2100	800	500	281	AL-F
BS.R20040.189	2100	800	500	329	AL-F
BS.R24040.189	2100	800	500	377	AL-F
BS.R28040.189	2100	800	500	407	AL-F

SAH extra-reinforced type with 215 Hz circuit breaker ($p = 5.41\%$)

Cat.Nos	Dimensions (mm)			Weight (kg)	Enclosure
	A	B	C		
BS.RS7240.215	2100	1000	600	240	AL-F
BS.RS14440.215	2100	1000	600	330	AL-F
BS.RS21640.215	2100	1000	600	420	AL-F
BS.RS28840.215	2100	1600	600	510	AL-F

PL2-F type enclosures (natural ventilation)

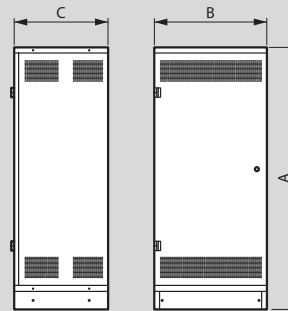

AL-F type enclosures (forced ventilation)

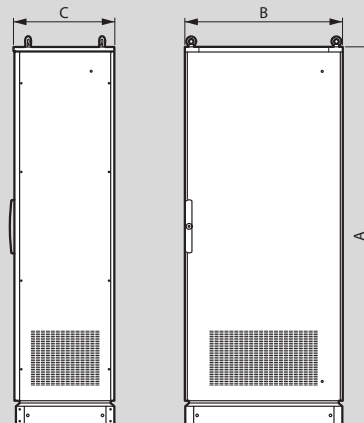

Optional lifting rings



Alpimatic automatic capacitor banks



M6040

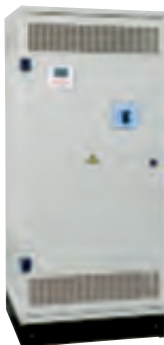

M15040/DISJ



Technical characteristics p. 28-29

400 V - 50 Hz three-phase network

IP 30 - IK 10 enclosure

Fully modular design for ease of maintenance

Alpimatic is made up of several enclosures depending on the capacitor bank model and the nominal current

The contactors are controlled by the Alptec power factor controller with a simple commissioning procedure

Step control using CTX³ electromechanical contactors with damping resistors suitable for capacitive currents

Capacitor banks without circuit breaker: connection via the top up to 125 kVAr and via the bottom up to 150 kVAr (via the top: on request)

Capacitor banks with circuit breaker: connection via the top

Grey enclosure (RAL 7035) with black base

Conforming to standard IEC 61921

Pack	Cat.Nos	S type		Pack	Cat.Nos	S type (continued)		Circuit breaker rating (A)	Breaking capacity (kA)
		Max. harmonic pollution level THDU ≤ 3%, THDI ≤ 10%				With circuit breaker			
		Without circuit breaker				Nominal power (kVAr)	Steps (kVAr)		
		Nominal power (kVAr)	Steps (kVAr)						
1	M1040 ¹	10	(2.5+2.5)+5	1	M1040/DISJ ¹	10	(2.5+2.5)+5	25	50
1	M12.540 ¹	12.5	(2.5+5)+5	1	M12.540/DISJ ¹	12.5	(2.5+5)+5	25	50
1	M1540 ¹	15	(2.5+5)+7.5	1	M1540/DISJ ¹	15	(2.5+5)+7.5	40	50
1	M2040 ¹	20	(2.5+5)+12.5	1	M2040/DISJ ¹	20	(2.5+5)+12.5	40	50
1	M2540 ¹	25	(5+10)+10	1	M2540/DISJ ¹	25	(5+10)+10	63	50
1	M3040 ¹	30	(5+10)+15	1	M3040/DISJ ¹	30	(5+10)+15	63	50
1	M3540 ¹	35	(5+10)+20	1	M3540/DISJ ¹	35	(5+10)+20	100	25
1	M4040 ¹	40	(5+10)+25	1	M4040/DISJ ¹	40	(5+10)+25	100	25
1	M47.540 ¹	47.5	(7.5+15)+25	1	M47.540/DISJ ¹	47.5	(7.5+15)+25	100	25
1	M5040 ¹	50	(10+15)+25	1	M5040/DISJ ¹	50	(10+15)+25	100	25
1	M6040 ¹	60	(10+25)+25	1	M6040/DISJ ¹	60	(10+25)+25	125	25
1	M67.540	67.5	(7.5 +15 +22.5)+22.5	1	M67.540/DISJ	67.5	(7.5 +15 +22.5)+22.5	125	25
1	M7540-F ¹	75	(25+25)+25	1	M7540-F/DISJ ¹	75	(25+25)+25	160	25
1	M7540	75	(7.5 +15 +22.5)+30	1	M7540/DISJ	75	(7.5 +15 +22.5)+30	160	25
1	M87.540-F	87.5	12.5+(25+50)	1	M87.540-F/DISJ	87.5	12.5+(25+50)	160	25
1	M87.540	87.5	(12.5 +25 +25)+25	1	M87.540/DISJ	87.5	(12.5 +25 +25)+25	160	25
1	M10040-F	100	25+(25+50)	1	M10040-F/DISJ	100	25+(25+50)	250	36
1	M10040	100	(12.5 +25 +25)+37.5	1	M10040/DISJ	100	(12.5 +25 +25)+37.5	250	36
1	M112.540	112.5	(12.5 +25 +25)+50	1	M112.540/DISJ	112.5	(12.5 +25 +25)+50	250	36
1	M12540	125	(25+50)+50	1	M12540/DISJ	125	(25+50)+50	250	36
1	M15040	150	(25+50)+75	1	M15040/DISJ	150	(25+50)+75	400	36
1	M17540	175	25+(25+50)+75	1	M17540/DISJ	175	25+(25+50)+75	400	36
1	M20040	200	50+2x75	1	M20040/DISJ	200	50+2x75	400	36
1	M22540	225	(25+50)+2x75	1	M22540/DISJ	225	(25+50)+2x75	630	36
1	M25040	250	2x50+2x75	1	M25040/DISJ	250	2x50+2x75	630	36
1	M27540	275	(25+50)+50+2x75	1	M27540/DISJ	275	(25+50)+50+2x75	630	36
1	M30040	300	(25+50)+3x75	1	M30040/DISJ	300	(25+50)+3x75	630	36
1	M35040	350	50+4x75	1	M35040/DISJ	350	50+4x75	1250	50
1	M40040	400	2x50+4x75	1	M40040/DISJ	400	2x50+4x75	1250	50
1	M45040	450	6x75	1	M45040/DISJ	450	6x75	1250	50
1	M50040	500	50+6x75	1	M50040/DISJ	500	50+6x75	1250	50
1	M55040	550	2x50+6x75	1	M55040/DISJ	550	2x50+6x75	1250	70
1	M60040	600	8x75	1	M60040/DISJ	600	8x75	1250	70
1	M67540	675	9x75						
1	M75040	750	10x75						
1	M82540	825	11x75						
1	M90040	900	12x75						

1: Wall mounting possible



For smoke detector, other power ratings, voltages, frequencies, air conditioning, IP 54, please consult us

Alpimatic automatic capacitor banks (continued)



MH35040/DISJ



 **Technical characteristics p. 28-29**

400 V - 50 Hz three-phase network. IP 30 - IK 10 enclosure Fully modular design for ease of maintenance
 Alpimatic is made up of several enclosures depending on the capacitor bank model and the nominal current
 The contactors are controlled by the Alptec power factor controller with a simple commissioning procedure
 Step control using CTX³ electromechanical contactors with damping resistors suitable for capacitive currents
 Capacitor banks without circuit breaker: connection via the top up to 125 kVAr and via the bottom up to 150 kVAr (via the top: on request)
 Capacitor banks with circuit breaker: connection via the top. RAL 7035 enclosure. Conforming to standard IEC 61921

Pack	Cat.Nos	H type	Pack	Cat.Nos	H type (continued)		
		Max. harmonic pollution level THDU ≤ 4%, THDI ≤ 15%			With circuit breaker		
		Without circuit breaker			Nominal power (kVAr)		
		Nominal power (kVAr)			Steps (kVAr)		
		Steps (kVAr)			Circuit breaker rating (A)		
					Breaking capacity (kA)		
1	MH1040 ¹	10 (2.5+2.5)+5	1	MH1040/DISJ	10 (2.5+2.5)+5	25	50
1	MH12.540 ¹	12.5 (2.5+5)+5	1	MH12.540/DISJ	12.5 (2.5+5)+5	25	50
1	MH1540 ¹	15 (2.5+5)+7.5	1	MH1540/DISJ	15 (2.5+5)+7.5	40	50
1	MH2040 ¹	20 (2.5+5)+12.5	1	MH2040/DISJ	20 (2.5+5)+12.5	40	50
1	MH2540 ¹	25 (5+10)+10	1	MH2540/DISJ	25 (5+10)+10	63	50
1	MH3040 ¹	30 (5+10)+15	1	MH3040/DISJ	30 (5+10)+15	63	50
1	MH3540 ¹	35 (5+10)+20	1	MH3540/DISJ	35 (5+10)+20	100	25
1	MH4040 ¹	40 (5+10)+25	1	MH4040/DISJ	40 (5+10)+25	100	25
1	MH47.540 ¹	47.5 (7.5+15)+25	1	MH47.540/DISJ	47.5 (7.5+15)+25	100	25
1	MH5040 ¹	50 (10+15)+25	1	MH5040/DISJ	50 (10+15)+25	100	25
1	MH6040 ¹	60 (10+25+25)	1	MH6040/DISJ	60 (10+25+25)	125	25
1	MH67.540	67.5 (7.5+15+22.5)+22.5	1	MH67.540/DISJ	67.5 (7.5+15+22.5)+22.5	125	25
1	MH7540-F ¹	75 (25+25+25)	1	MH7540-F/DISJ	75 (25+25+25)	160	25
1	MH7540	75 (7.5+15+22.5)+30	1	MH7540/DISJ	75 (7.5+15+22.5)+30	160	25
1	MH87.540-F	87.5 12.5+(25+50)	1	MH87.540-F/DISJ	87.5 12.5+(25+50)	160	25
1	MH87.540	87.5 (12.5+25+25)+25	1	MH87.540/DISJ	87.5 (12.5+25+25)+25	160	25
1	MH10040-F	100 25+(25+50)	1	MH10040-F/DISJ	100 25+(25+50)	250	36
1	MH10040	100 (12.5+25+25)+37.5	1	MH10040/DISJ	100 (12.5+25+25)+37.5	250	36
1	MH112.540	112.5 (12.5+25+25)+50	1	MH112.540/DISJ	112.5 (12.5+25+25)+50	250	36
1	MH12540	125 (25+50)+50	1	MH12540/DISJ	125 (25+50)+50	250	36
1	MH15040	150 (25+50)+75	1	MH15040/DISJ	150 (25+50)+75	400	36
1	MH17540	175 25+(25+50)+75	1	MH17540/DISJ	175 25+(25+50)+75	400	36
1	MH20040	200 50+2x75	1	MH20040/DISJ	200 50+2x75	400	36
1	MH22540	225 (25+50)+2x75	1	MH22540/DISJ	225 (25+50)+2x75	630	36
1	MH25040	250 2x50+2x75	1	MH25040/DISJ	250 2x50+2x75	630	36
1	MH27540	275 (25+50)+50+2x75	1	MH27540/DISJ	275 (25+50)+50+2x75	630	36
1	MH30040	300 (25+50)+3x75	1	MH30040/DISJ	300 (25+50)+3x75	630	36
1	MH35040	350 50+4x75	1	MH35040/DISJ	350 50+4x75	1250	50
1	MH40040	400 2x50+4x75	1	MH40040/DISJ	400 2x50+4x75	1250	50
1	MH45040	450 6x75	1	MH45040/DISJ	450 6x75	1250	50
1	MH50040	500 50+6x75	1	MH50040/DISJ	500 50+6x75	1250	50
1	MH55040	550 2x50+6x75	1	MH55040/DISJ	550 2x50+6x75	1250	70
1	MH60040	600 8x75	1	MH60040/DISJ	600 8x75	1250	70
1	MH67540	675 9x75					
1	MH75040	750 10x75					
1	MH82540	825 11x75					
1	MH90040	900 12x75					

1: Wall mounting possible

 For smoke detector, other power ratings, voltages, frequencies, air conditioning, IP 54, **please consult us**



Alpimatic automatic capacitor banks with detuned reactor



MS15040.189



MS25040.189/DISJ



Technical characteristics p. 28-30

400 V - 50 Hz three-phase network. IP 30 - IK 10 enclosure
 Fully modular design for ease of maintenance
 Alpimatic with detuned reactor is made up of several enclosures depending on the capacitor bank model and the nominal current
 The contactors are controlled by the Alptec power factor controller with a simple commissioning procedure
 Step control using CTX³ electromechanical contactors
 Capacitor banks without circuit breaker: connection via the bottom (or via the top on request)
 Capacitor banks with circuit breaker: connection via the top
 Grey enclosure (RAL 7035) with black base Conforming to standard IEC 61921

Pack	Cat.Nos	SAH type			
		Max. harmonic pollution level THDU ≤ 6%, THDI ≤ 30%			
		Without circuit breaker - 189 Hz (p = 7%)			
		Nominal power (kVar)	Steps (kVar)		
1	MS7540.189	75	25(+50)		
1	MS10040.189	100	2x25+50		
1	MS12540.189	125	25+2x50		
1	MS15040.189	150	3x50		
1	MS20040.189	200	50+2x75		
1	MS22540.189	225	3x75		
1	MS25040.189	250	2x50+2x75		
1	MS27540.189	275	50+3x75		
1	MS30040.189	300	4x75		
1	MS35040.189	350	50+4x75		
1	MS37540.189	375	5x75		
1	MS45040.189	450	6x75		
1	MS52540.189	525	7x75		
1	MS60040.189	600	8x75		
1	MS67540.189	675	9x75		
1	MS75040.189	750	10x75		
		With circuit breaker - 189 Hz (p = 7%)			
		Nominal power (kVar)	Steps (kVar)	Circuit breaker rating (A)	Breaking capacity (kA)
1	MS7540.189/DISJ	75	25(+50)	160	25
1	MS10040.189/DISJ	100	2x25+50	250	36
1	MS12540.189/DISJ	125	25+2x50	250	36
1	MS15040.189/DISJ	150	3x50	400	36
1	MS20040.189/DISJ	200	50+2x75	400	36
1	MS22540.189/DISJ	225	3x75	630	36
1	MS25040.189/DISJ	250	2x50+2x75	630	36
1	MS27540.189/DISJ	275	50+3x75	630	36
1	MS30040.189/DISJ	300	4x75	630	36
1	MS35040.189/DISJ	350	50+4x75	1250	50
1	MS37540.189/DISJ	375	5x75	1250	50
1	MS45040.189/DISJ	450	6x75	1250	50
1	MS52540.189/DISJ	525	7x75	1250	70
1	MS60040.189/DISJ	600	8x75	1250	70

Pack	Cat.Nos	SAH type (continued)			
		Without circuit breaker - 135 Hz (p = 14%)			
		Nominal power (kVar)	Steps (kVar)		
1	MS5240.135	52.5	3x17.5		
1	MS7040.135	70	2x17.5+35		
1	MS8740.135	87.5	17.5+2x35		
1	MS10540.135	105	2x17.5+2x35		
1	MS14040.135	140	2x35+70		
1	MS17540.135	175	35+2x70		
1	MS21040.135	210	2x35+2x70		
1	MS24540.135	245	35+3x70		
1	MS28040.135	280	2x35+3x70		
1	MS31540.135	315	35+4x70		
1	MS38540.135	385	35+5x70		
1	MS42040.135	420	6x70		
1	MS45540.135	455	35+6x70		
1	MS49040.135	490	7x70		
1	MS52540.135	525	35+7x70		
1	MS56040.135	560	8x70		
1	MS63040.135	630	9x70		
		With circuit breaker - 135 Hz (p = 14%)			
		Nominal power (kVar)	Steps (kVar)	Circuit breaker rating (A)	Breaking capacity (kA)
1	MS5240.135/DISJ	52.5	3x17.5	100	25
1	MS7040.135/DISJ	70	2x17.5+35	160	25
1	MS8740.135/DISJ	87.5	17.5+2x35	160	36
1	MS10540.135/DISJ	105	2x17.5+2x35	250	36
1	MS14040.135/DISJ	140	2x35+70	400	36
1	MS17540.135/DISJ	175	35+2x70	400	36
1	MS21040.135/DISJ	210	2x35+2x70	630	36
1	MS24540.135/DISJ	245	35+3x70	630	36
1	MS28040.135/DISJ	280	2x35+3x70	630	36
1	MS31540.135/DISJ	315	35+4x70	630	36
1	MS38540.135/DISJ	385	35+5x70	1250	50
1	MS42040.135/DISJ	420	6x70	1250	50
1	MS45540.135/DISJ	455	35+6x70	1250	50
1	MS49040.135/DISJ	490	7x70	1250	50
1	MS52540.135/DISJ	525	35+7x70	1250	70
1	MS56040.135/DISJ	560	8x70	1250	70

Alpimatic automatic capacitor banks with detuned reactor (continued)



MS.R28040.189

Technical characteristics **p. 28-30**

400 V - 50 Hz three-phase network
 IP 30 - IK 10 enclosure
 Fully modular design for ease of maintenance
 Alpimatic with detuned reactor is made up of several enclosures depending on the capacitor bank model and the nominal current
 The contactors are controlled by the Alptec power factor controller with a simple commissioning procedure
 Step control using CTX³ electromechanical contactors
 Capacitor banks without circuit breaker: connection via the bottom (or via the top on request)
 Capacitor banks with circuit breaker: connection via the top
 Grey enclosure (RAL 7035) with black base
 Conforming to standard IEC 61921

Pack	Cat.Nos	SAH reinforced type			
		Max. harmonic pollution level THDU ≤ 8%, THDI ≤ 40%			
		Without circuit breaker - 189 Hz (p = 7%)			
		Nominal power (kVAr)	Steps (kVAr)		
1	MS.R12040.189	120	3x40		
1	MS.R16040.189	160	2x40+80		
1	MS.R20040.189	200	40+2x80		
1	MS.R24040.189	240	3x80		
1	MS.R28040.189	280	40+3x80		
1	MS.R32040.189	320	4x80		
1	MS.R36040.189	360	40+4x80		
1	MS.R40040.189	400	5x80		
1	MS.R44040.189	440	40+5x80		
1	MS.R48040.189	480	6x80		
1	MS.R52040.189	520	40+6x80		
1	MS.R56040.189	560	7x80		
1	MS.R60040.189	600	40+7x80		
1	MS.R64040.189	640	8x80		
1	MS.R72040.189	720	9x80		
1	MS.R80040.189	800	10x80		
		With circuit breaker - 189 Hz (p = 7%)			
		Nominal power (kVAr)	Steps (kVAr)	Circuit breaker rating (A)	Breaking capacity (kA)
1	MS.R12040.189/DISJ	120	3x40	250	36
1	MS.R16040.189/DISJ	160	2x40+80	400	36
1	MS.R20040.189/DISJ	200	40+2x80	400	36
1	MS.R24040.189/DISJ	240	3x80	630	36
1	MS.R28040.189/DISJ	280	40+3x80	630	36
1	MS.R32040.189/DISJ	320	4x80	630	36
1	MS.R36040.189/DISJ	360	40+4x80	1250	50
1	MS.R40040.189/DISJ	400	5x80	1250	50
1	MS.R44040.189/DISJ	440	40+5x80	1250	50
1	MS.R48040.189/DISJ	480	6x80	1250	50
1	MS.R52040.189/DISJ	520	40+6x80	1250	70
1	MS.R56040.189/DISJ	560	7x80	1250	70
1	MS.R60040.189/DISJ	600	40+7x80	1250	70

Pack	Cat.Nos	SAH extra-reinforced type			
		Max. harmonic pollution level THDU ≤ 11%, THDI ≤ 55%			
		At this level of harmonic pollution, we strongly recommend that you contact us to take measurements on site			
		Without circuit breaker - 215 Hz (p = 5.41%)			
		Nominal power (kVAr)	Steps (kVAr)		
1	MS.RS14440.215	144	2x72		
1	MS.RS21640.215	216	3x72		
1	MS.RS28840.215	288	4x72		
1	MS.RS36040.215	360	5x72		
1	MS.RS43240.215	432	6x72		
1	MS.RS50440.215	504	7x72		
1	MS.RS57640.215	576	8x72		
1	MS.RS64840.215	648	9x72		
1	MS.RS72040.215	720	10x72		
1	MS.RS79240.215	792	11x72		
1	MS.RS86440.215	864	12x72		
		With circuit breaker - 215 Hz (p = 5.41%)			
		Nominal power (kVAr)	Steps (kVAr)	Circuit breaker rating (A)	Breaking capacity (kA)
1	MS.RS14440.215/DISJ	144	2x72	400	36
1	MS.RS21640.215/DISJ	216	3x72	630	36
1	MS.RS28840.215/DISJ	288	4x72	1250	50
1	MS.RS36040.215/DISJ	360	5x72	1250	50
1	MS.RS43240.215/DISJ	432	6x72	1250	70
1	MS.RS50440.215/DISJ	504	7x72	1250	70
1	MS.RS57640.215/DISJ	576	8x72	1600	70

For smoke detector, other power ratings, voltages, frequencies, air conditioning IP 54, **please consult us**



Alpimatic automatic capacitor banks

Alpimatic automatic capacitor banks with detuned reactor

■ Dimensions

PL1 type enclosure (natural ventilation)

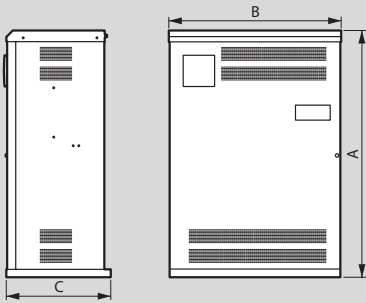

PL2 type enclosure (natural ventilation)

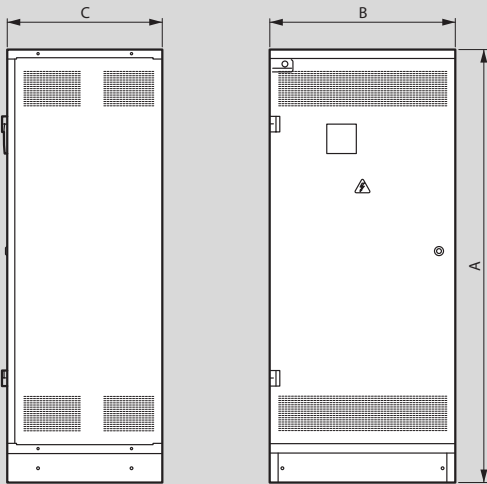

■ Dimensions

PL2 type enclosure (natural ventilation)

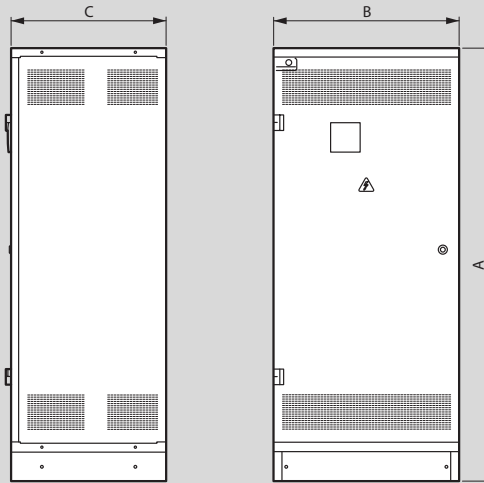

AL type enclosure (forced ventilation)

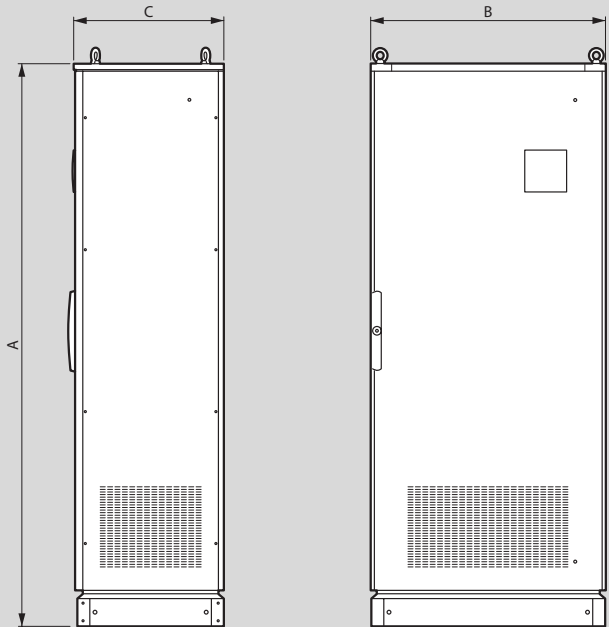

Optional lifting rings

Alpimatic automatic capacitor banks

■ Dimensions

S type - without circuit breaker

Cat.Nos	Dimensions (mm)			Weight (kg)	Enclosure
	A	B	C		
M1040	770	260	320	23	PL1
M12.540	770	260	320	24	PL1
M1540	770	260	320	25	PL1
M2040	770	260	320	25	PL1
M2540	770	260	320	25	PL1
M3040	770	260	320	28	PL1
M3540	770	260	320	28	PL1
M4040	770	260	320	29	PL1
M47.540	770	260	320	29	PL1
M5040	770	260	320	30	PL1
M6040	770	260	320	30	PL1
M67.540	770	520	320	40	PL1
M7540-F	770	260	320	32	PL1
M7540	770	520	320	42	PL1
M87.540-F	770	520	320	44	PL1
M87.540	770	520	320	44	PL1
M10040-F	770	520	320	44	PL1
M10040	770	520	320	45	PL1
M112.540	770	520	320	45	PL1
M12540	770	520	320	50	PL1
M15040	770	520	320	53	PL1
M17540	1400	600	500	110	PL2
M20040	1400	600	500	115	PL2
M22540	1400	600	500	120	PL2
M25040	1400	600	500	125	PL2
M27540	1400	600	500	130	PL2
M30040	1400	600	500	135	PL2
M35040	1900	600	500	165	PL2
M40040	1900	600	500	175	PL2
M45040	1900	600	500	185	PL2
M50040	1900	1200	500	230	PL2
M55040	1900	1200	500	240	PL2
M60040	1900	1200	500	250	PL2
M67540	1900	1200	500	325	PL2
M75040	1900	1200	500	340	PL2
M82540	1900	1200	500	355	PL2
M90040	1900	1200	500	370	PL2

S type - with circuit breaker

Cat.Nos	Dimensions (mm)			Weight (kg)	Enclosure
	A	B	C		
M1040/DISJ	770	260	320	23	PL1
M12.540/DISJ	770	260	320	24	PL1
M1540/DISJ	770	260	320	25	PL1
M2040/DISJ	770	260	320	25	PL1
M2540/DISJ	770	260	320	25	PL1
M3040/DISJ	770	260	320	28	PL1
M3540/DISJ	770	260	320	28	PL1
M4040/DISJ	770	260	320	29	PL1
M47.540/DISJ	770	260	320	29	PL1
M5040/DISJ	770	260	320	31	PL1
M6040/DISJ	770	260	320	31	PL1
M67.540/DISJ	770	520	320	41	PL1
M7540-F/DISJ	770	260	320	33	PL1
M7540/DISJ	770	520	320	43	PL1
M87.540-F/DISJ	770	520	320	45	PL1
M87.540/DISJ	770	520	320	45	PL1
M10040-F/DISJ	770	520	320	45	PL1
M10040/DISJ	770	520	320	46	PL1
M112.540/DISJ	770	520	320	46	PL1
M12540/DISJ	770	520	320	53	PL1
M15040/DISJ	1400	600	500	110	PL2
M17540/DISJ	1900	600	500	140	PL2
M20040/DISJ	1900	600	500	145	PL2
M22540/DISJ	1900	600	500	150	PL2
M25040/DISJ	1900	600	500	155	PL2
M27540/DISJ	1900	600	500	160	PL2
M30040/DISJ	1900	600	500	165	PL2
M35040/DISJ	1400	1200	500	250	PL2
M40040/DISJ	1900	1200	500	280	PL2
M45040/DISJ	1900	1200	500	290	PL2
M50040/DISJ	1900	1200	500	300	PL2
M55040/DISJ	1900	1200	500	310	PL2
M60040/DISJ	1900	1200	500	320	PL2

■ Dimensions (continued)

H type - without circuit breaker

Cat.Nos	Dimensions (mm)			Weight (kg)	Enclosure
	A	B	C		
MH1040	770	260	320	23	PL1
MH12.540	770	260	320	24	PL1
MH1540	770	260	320	25	PL1
MH2040	770	260	320	25	PL1
MH2540	770	260	320	25	PL1
MH3040	770	260	320	28	PL1
MH3540	770	260	320	28	PL1
MH4040	770	260	320	29	PL1
MH47.540	770	260	320	29	PL1
MH5040	770	260	320	30	PL1
MH6040	770	260	320	30	PL1
MH67.540	770	520	320	40	PL1
MH7540-F	770	260	320	32	PL1
MH7540	770	520	320	42	PL1
MH87.540-F	770	520	320	44	PL1
MH87.540	770	520	320	44	PL1
MH10040-F	770	520	320	44	PL1
MH10040	770	520	320	45	PL1
MH112.540	770	520	320	45	PL1
MH12540	770	520	320	50	PL1
MH15040	770	520	320	53	PL1
MH17540	1400	600	500	110	PL2
MH20040	1400	600	500	115	PL2
MH22540	1400	600	500	120	PL2
MH25040	1400	600	500	125	PL2
MH27540	1400	600	500	130	PL2
MH30040	1400	600	500	135	PL2
MH35040	1900	600	500	165	PL2
MH40040	1900	600	500	175	PL2
MH45040	1900	600	500	185	PL2
MH50040	1900	1200	500	230	PL2
MH55040	1900	1200	500	240	PL2
MH60040	1900	1200	500	250	PL2
MH67540	1900	1200	500	325	PL2
MH75040	1900	1200	500	340	PL2
MH82540	1900	1200	500	355	PL2
MH90040	1900	1200	500	370	PL2

H type - with circuit breaker

Cat.Nos	Dimensions (mm)			Weight (kg)	Enclosure
	A	B	C		
MH1040/DISJ	770	260	320	23	PL1
MH12.540/DISJ	770	260	320	24	PL1
MH1540/DISJ	770	260	320	25	PL1
MH2040/DISJ	770	260	320	25	PL1
MH2540/DISJ	770	260	320	25	PL1
MH3040/DISJ	770	260	320	28	PL1
MH3540/DISJ	770	260	320	28	PL1
MH4040/DISJ	770	260	320	29	PL1
MH47.540/DISJ	770	260	320	29	PL1
MH5040/DISJ	770	260	320	31	PL1
MH6040/DISJ	770	260	320	31	PL1
MH67.540/DISJ	770	520	320	41	PL1
MH7540-F/DISJ	770	260	320	33	PL1
MH7540/DISJ	770	520	320	43	PL1
MH87.540-F/DISJ	770	520	320	45	PL1
MH87.540/DISJ	770	520	320	45	PL1
MH10040-F/DISJ	770	520	320	45	PL1
MH10040/DISJ	770	520	320	46	PL1
MH112.540/DISJ	770	520	320	46	PL1
MH12540/DISJ	770	520	320	53	PL1
MH15040/DISJ	1400	600	500	110	PL2
MH17540/DISJ	1900	600	500	140	PL2
MH20040/DISJ	1900	600	500	145	PL2
MH22540/DISJ	1900	600	500	150	PL2
MH25040/DISJ	1900	600	500	155	PL2
MH27540/DISJ	1900	600	500	160	PL2
MH30040/DISJ	1900	600	500	165	PL2
MH35040/DISJ	1900	1200	500	250	PL2
MH40040/DISJ	1900	1200	500	280	PL2
MH45040/DISJ	1900	1200	500	290	PL2
MH50040/DISJ	1900	1200	500	300	PL2
MH55040/DISJ	1900	1200	500	310	PL2
MH60040/DISJ	1900	1200	500	320	PL2

Alpimatic automatic capacitor banks with detuned reactor

■ Dimensions (continued)

SAH type - without circuit breaker - 189 Hz ($p = 7\%$)

Cat.Nos	Dimensions (mm)			Weight (kg)	Enclosure
	A	B	C		
MS7540.189	1400	600	500	124	PL2
MS10040.189	1400	600	500	158	PL2
MS12540.189	1400	600	500	164	PL2
MS15040.189	1400	600	500	170	PL2
MS20040.189	2100	800	500	266	AL
MS22540.189	2100	800	500	275	AL
MS25040.189	2100	800	500	307	AL
MS27540.189	2100	800	500	316	AL
MS30040.189	2100	800	500	325	AL
MS35040.189	2100	800	500	366	AL
MS37540.189	2100	800	500	375	AL
MS45040.189	2100	1600	500	525	AL
MS52540.189	2100	1600	500	575	AL
MS60040.189	2100	1600	500	625	AL
MS67540.189	2100	1600	500	627	AL
MS75040.189	2100	1600	500	725	AL

SAH type - with circuit breaker - 189 Hz ($p = 7\%$)

Cat.Nos	Dimensions (mm)			Weight (kg)	Enclosure
	A	B	C		
MS7540.189/DISJ	1900	600	500	164	PL2
MS10040.189/DISJ	2100	800	500	226	AL
MS12540.189/DISJ	2100	800	500	236	AL
MS15040.189/DISJ	2100	800	500	245	AL
MS20040.189/DISJ	2100	800	500	286	AL
MS22540.189/DISJ	2100	800	500	295	AL
MS25040.189/DISJ	2100	800	500	327	AL
MS27540.189/DISJ	2100	800	500	336	AL
MS30040.189/DISJ	2100	800	500	345	AL
MS35040.189/DISJ	2100	1600	500	486	AL
MS37540.189/DISJ	2100	1600	500	495	AL
MS45040.189/DISJ	2100	1600	500	545	AL
MS52540.189/DISJ	2100	1600	500	595	AL
MS60040.189/DISJ	2100	1600	500	645	AL

SAH type - without circuit breaker - 135 Hz ($p = 14\%$)

Cat.Nos	Dimensions (mm)			Weight (kg)	Enclosure
	A	B	C		
MS5240.135	1400	600	500	124	PL2
MS7040.135	1400	600	500	130	PL2
MS8740.135	1400	600	500	164	PL2
MS10540.135	2100	800	500	216	AL
MS14040.135	2100	800	500	225	AL
MS17540.135	2100	800	500	266	AL
MS21040.135	2100	800	500	275	AL
MS24540.135	2100	800	500	316	AL
MS28040.135	2100	800	500	325	AL
MS31540.135	2100	800	500	366	AL
MS38540.135	2100	1600	500	516	AL
MS42040.135	2100	1600	500	525	AL
MS45540.135	2100	1600	500	566	AL
MS49040.135	2100	1600	500	575	AL
MS52540.135	2100	1600	500	616	AL
MS56040.135	2100	1600	500	625	AL
MS63040.135	2100	1600	500	675	AL

SAH type - with circuit breaker - 135 Hz ($p = 14\%$)

Cat.Nos	Dimensions (mm)			Weight (kg)	Enclosure
	A	B	C		
MS5240.135/DISJ	2100	800	500	221	AL
MS7040.135/DISJ	2100	800	500	227	AL
MS8740.135/DISJ	2100	800	500	250	AL
MS10540.135/DISJ	2100	800	500	236	AL
MS14040.135/DISJ	2100	800	500	245	AL
MS17540.135/DISJ	2100	800	500	286	AL
MS21040.135/DISJ	2100	800	500	295	AL
MS24540.135/DISJ	2100	800	500	336	AL
MS28040.135/DISJ	2100	1600	500	445	AL
MS31540.135/DISJ	2100	1600	500	486	AL
MS38540.135/DISJ	2100	1600	500	536	AL
MS42040.135/DISJ	2100	1600	500	545	AL
MS45540.135/DISJ	2100	1600	500	586	AL
MS49040.135/DISJ	2100	1600	500	595	AL
MS52540.135/DISJ	2100	1600	500	636	AL
MS56040.135/DISJ	2100	1600	500	645	AL

■ Dimensions (continued)

SAH reinforced type - without circuit breaker - 189 Hz ($p = 7\%$)

Cat.Nos	Dimensions (mm)			Weight (kg)	Enclosure
	A	B	C		
MS.R12040.189	1400	600	500	191	PL2
MS.R16040.189	2100	800	500	299	AL
MS.R20040.189	2100	800	500	328	AL
MS.R24040.189	2100	800	500	359	AL
MS.R28040.189	2100	800	500	407	AL
MS.R32040.189	2100	800	500	437	AL
MS.R36040.189	2100	800	500	485	AL
MS.R40040.189	2100	800	500	515	AL
MS.R44040.189	2100	1600	500	663	AL
MS.R48040.189	2100	1600	500	693	AL
MS.R52040.189	2100	1600	500	741	AL
MS.R56040.189	2100	1600	500	771	AL
MS.R60040.189	2100	1600	500	811	AL
MS.R64040.189	2100	1600	500	849	AL
MS.R72040.189	2100	1600	500	927	AL
MS.R80040.189	2100	1600	500	1005	AL

SAH reinforced type - with circuit breaker - 189 Hz ($p = 7\%$)

Cat.Nos	Dimensions (mm)			Weight (kg)	Enclosure
	A	B	C		
MS.R12040.189/DISJ	2100	800	500	289	AL
MS.R16040.189/DISJ	2100	800	500	319	AL
MS.R20040.189/DISJ	2100	800	500	348	AL
MS.R24040.189/DISJ	2100	800	500	379	AL
MS.R28040.189/DISJ	2100	800	500	427	AL
MS.R32040.189/DISJ	2100	800	500	457	AL
MS.R36040.189/DISJ	2100	1600	500	605	AL
MS.R40040.189/DISJ	2100	1600	500	635	AL
MS.R44040.189/DISJ	2100	1600	500	683	AL
MS.R48040.189/DISJ	2100	1600	500	713	AL
MS.R52040.189/DISJ	2100	1600	500	761	AL
MS.R56040.189/DISJ	2100	1600	500	791	AL
MS.R60040.189/DISJ	2100	1600	500	831	AL

SAH extra-reinforced type - without circuit breaker - 215 Hz ($p = 5.41\%$)

Cat.Nos	Dimensions (mm)			Weight (kg)	Enclosure
	A	B	C		
MS.RS14440.215	2100	1000	600	330	AL
MS.RS21640.215	2100	1000	600	420	AL
MS.RS28840.215	2100	1000	600	510	AL
MS.RS36040.215	2100	2000	600	725	AL
MS.RS43240.215	2100	2000	600	815	AL
MS.RS50440.215	2100	2000	600	905	AL
MS.RS57640.215	2100	2000	600	995	AL
MS.RS64840.215	2100	3000	600	1210	AL
MS.RS72040.215	2100	3000	600	1300	AL
MS.RS79240.215	2100	3000	600	1390	AL
MS.RS86440.215	2100	3000	600	1480	AL

SAH extra-reinforced type with circuit breaker - 215 Hz ($p = 5.41\%$)

Cat.Nos	Dimensions (mm)			Weight (kg)	Enclosure
	A	B	C		
MS.RS14440.215/DISJ	2100	1000	600	350	AL
MS.RS21640.215/DISJ	2100	1000	600	440	AL
MS.RS28840.215/DISJ	2100	1400	600	610	AL
MS.RS36040.215/DISJ	2100	2000	600	745	AL
MS.RS43240.215/DISJ	2100	2000	600	915	AL
MS.RS50440.215/DISJ	2100	2400	600	1025	AL
MS.RS57640.215/DISJ	2100	2400	600	1115	AL

Alpistatic automatic capacitor banks with detuned reactor



STS 25040.189/DISJ

 **Technical characteristics p. 33**

400 V - 50 Hz three-phase network

IP 30 - IK 10 enclosure

Alpistatic with detuned reactor is a real-time compensation system, with a response time ≤ 40 ms

Step control using thyristor-controlled solid state contactors

It is specially designed for sites using rapidly changing loads, or for processes sensitive to harmonics and transient currents.

All levels can be connected or disconnected at the same time, in order to correspond exactly to your reactive energy demand.

Alpistatic with detuned reactor is made up of several static enclosures depending on the capacitor bank model and the nominal current

Capacitor banks without circuit breaker: connection via the bottom (or via the top on request)

Capacitor banks with circuit breaker: connection via the top

Grey enclosure (RAL 7035) with black base

Conforming to standard IEC 61921

Pack	Cat.Nos	SAH type	
		Max. harmonic pollution level THDU $\leq 6\%$, THDI $\leq 30\%$	
		Without circuit breaker - 189 Hz (p = 7%)	
		Nominal power (kVar)	Steps (kVar)
1	STS10040.189	100	2x25+50
1	STS12540.189	125	25+2x50
1	STS15040.189	150	3x50
1	STS17540.189	175	2x50+75
1	STS20040.189	200	50+2x75
1	STS22540.189	225	25+50+2x75
1	STS25040.189	250	2x50+2x75
1	STS27540.189	275	50+3x75
1	STS30040.189	300	2x50+2x100
1	STS35040.189	350	50+3x100
1	STS40040.189	400	4x100
1	STS45040.189	450	75+3x125
1	STS50040.189	500	4x125
1	STS52540.189	525	2x75+3x125
1	STS57540.189	575	75+4x125
1	STS62540.189	625	5x125
1	STS70040.189	700	75+5x125
1	STS75040.189	750	6x125
1	STS82540.189	825	75+6x125
1	STS87540.189	875	7x125
1	STS95040.189	950	75+7x125
1	STS100040.189	1000	8x125
1	STS112540.189	1125	9x125
1	STS125040.189	1250	10x125
1	STS137540.189	1375	11x125
1	STS150040.189	1500	12x125

Pack	Cat.Nos	SAH type (continued)			
		With circuit breaker - 189 Hz (p = 7%)			
		Nominal power (kVar)	Steps (kVar)	Circuit breaker rating (A)	Breaking capacity (kA)
1	STS10040.189/DISJ	100	2x25+50	250	36
1	STS12540.189/DISJ	125	25+2x50	250	36
1	STS15040.189/DISJ	150	3x50	400	36
1	STS17540.189/DISJ	175	2x50+75	400	36
1	STS20040.189/DISJ	200	50+2x75	400	36
1	STS22540.189/DISJ	225	25+50+2x75	630	36
1	STS25040.189/DISJ	250	2x50+2x75	630	36
1	STS27540.189/DISJ	275	50+3x75	630	36
1	STS30040.189/DISJ	300	2x50+2x100	630	36
1	STS35040.189/DISJ	350	50+3x100	1250	50
1	STS40040.189/DISJ	400	4x100	1250	50
1	STS45040.189/DISJ	450	75+3x125	1250	50
1	STS50040.189/DISJ	500	4x125	1250	50
1	STS52540.189/DISJ	525	2x75+3x125	1250	70
1	STS57540.189/DISJ	575	75+4x125	1250	70
1	STS62540.189/DISJ	625	5x125	1250	70
1	STS70040.189/DISJ	700	75+5x125	1250	70

 For smoke detector, other power ratings, voltages, frequencies, air conditioning, IP 54, **please consult us**



Alpistic automatic capacitor banks with detuned reactor (continued)



STS.R28040.189

Technical characteristics p. 33

400 V - 50 Hz three-phase network. IP 30 - IK 10 enclosure

Alpistic with detuned reactor is a real-time compensation system, with a response time ≤ 40 ms

Step control using thyristor-controlled solid state contactors. It is specially designed for sites using rapidly changing loads, or for processes sensitive to harmonics and transient currents

All levels can be connected or disconnected at the same time, in order to correspond exactly to your reactive energy demand

Alpistic with detuned reactor is made up of several enclosures depending on the capacitor bank model and the nominal current

Capacitor banks without circuit breaker: connection via the bottom (or via the top on request). Capacitor banks with circuit breaker: connection via the top

Grey enclosure (RAL 7035) with black base Conforming to standard IEC 61921

Pack	Cat.Nos	SAH reinforced type			
		Max. harmonic pollution level THDU $\leq 8\%$, THDI $\leq 40\%$			
		Without circuit breaker - 189 Hz ($p = 7\%$)			
		Nominal power (kVAr)	Steps (kVAr)		
1	STS.R12040.189	120	40(+80)		
1	STS.R16040.189	160	2x40+80		
1	STS.R20040.189	200	40+2x80		
1	STS.R24040.189	240	2x40+2x80		
1	STS.R28040.189	280	40+3x80		
1	STS.R32040.189	320	4x80		
1	STS.R36040.189	360	40+4x80		
1	STS.R40040.189	400	5x80		
1	STS.R44040.189	440	80+3x120		
1	STS.R48040.189	480	4x120		
1	STS.R52040.189	520	2x80+3x120		
1	STS.R56040.189	560	80+4x120		
1	STS.R60040.189	600	5x120		
1	STS.R68040.189	680	80+5x120		
1	STS.R72040.189	720	6x120		
1	STS.R80040.189	800	80+6x120		
1	STS.R84040.189	840	7x120		
1	STS.R92040.189	920	80+7x120		
1	STS.R96040.189	960	8x120		
1	STS.R108040.189	1080	9x120		
1	STS.R120040.189	1200	10x120		
1	STS.R132040.189	1320	11x120		
1	STS.R144040.189	1440	12x120		
		With circuit breaker - 189 Hz ($p = 7\%$)			
		Nominal power (kVAr)	Steps (kVAr)	Circuit breaker rating (A)	Breaking capacity (kA)
1	STS.R12040.189/DISJ	120	40(+80)	250	36
1	STS.R16040.189/DISJ	160	2x40+80	400	36
1	STS.R20040.189/DISJ	200	40+2x80	400	36
1	STS.R24040.189/DISJ	240	2x40+2x80	630	36
1	STS.R28040.189/DISJ	280	40+3x80	630	36
1	STS.R32040.189/DISJ	320	4x80	630	36
1	STS.R36040.189/DISJ	360	40+4x80	1250	50
1	STS.R40040.189/DISJ	400	5x80	1250	50
1	STS.R44040.189/DISJ	440	80+3x120	1250	50
1	STS.R48040.189/DISJ	480	4x120	1250	50
1	STS.R52040.189/DISJ	520	2x80+3x120	1250	70
1	STS.R56040.189/DISJ	560	80+4x120	1250	70
1	STS.R60040.189/DISJ	600	5x120	1250	70
1	STS.R68040.189/DISJ	680	80+5x120	1250	70

Pack	Cat.Nos	SAH extra-reinforced type			
		Max. harmonic pollution level THDU $\leq 11\%$, THDI $\leq 55\%$			
		At this level of harmonic pollution, we strongly recommend that you contact us to take measurements on site			
		Without circuit breaker - 215 Hz ($p = 5.41\%$)			
		Nominal power (kVAr)	Steps (kVAr)		
1	STS.RS14440.215	144	2x72		
1	STS.RS21640.215	216	3x72		
1	STS.RS28840.215	288	4x72		
1	STS.RS36040.215	360	5x72		
1	STS.RS43240.215	432	6x72		
1	STS.RS50440.215	504	7x72		
1	STS.RS57640.215	576	8x72		
1	STS.RS64840.215	648	9x72		
1	STS.RS72040.215	720	10x72		
1	STS.RS79240.215	792	11x72		
1	STS.RS86440.215	864	12x72		
		With circuit breaker - 215 Hz ($p = 5.41\%$)			
		Nominal power (kVAr)	Steps (kVAr)	Circuit breaker rating (A)	Breaking capacity (kA)
1	STS.RS14440.215/DISJ	144	2x72	400	36
1	STS.RS21640.215/DISJ	216	3x72	630	36
1	STS.RS28840.215/DISJ	288	4x72	1250	50
1	STS.RS36040.215/DISJ	360	5x72	1250	50
1	STS.RS43240.215/DISJ	432	6x72	1250	70
1	STS.RS50440.215/DISJ	504	7x72	1250	70
1	STS.RS57640.215/DISJ	576	8x72	1600	70

Alpistatic automatic capacitor banks with detuned reactor

Dimensions

AL type enclosures (forced ventilation)

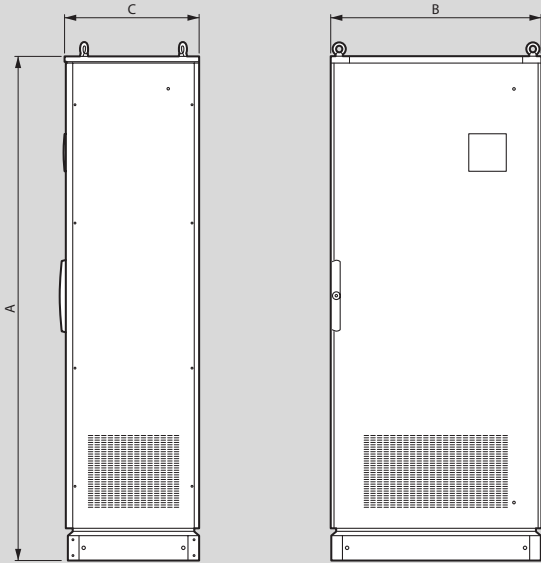

Optional lifting rings

SAH type - without circuit breaker - 189 Hz (p = 7%)

Cat.Nos	Dimensions (mm)			Weight (kg)	Enclosure
	A	B	C		
STS10040.189	2100	800	500	195	AL
STS12540.189	2100	800	500	215	AL
STS15040.189	2100	800	500	235	AL
STS17540.189	2100	800	500	255	AL
STS20040.189	2100	800	500	275	AL
STS22540.189	2100	800	500	295	AL
STS25040.189	2100	800	500	315	AL
STS27540.189	2100	800	500	335	AL
STS30040.189	2100	1000	600	360	AL
STS35040.189	2100	1000	600	395	AL
STS40040.189	2100	1000	600	430	AL
STS45040.189	2100	1000	600	470	AL
STS50040.189	2100	1000	600	510	AL
STS52540.189	2100	2000	600	640	AL
STS57540.189	2100	2000	600	680	AL
STS62540.189	2100	2000	600	720	AL
STS70040.189	2100	2000	600	780	AL
STS75040.189	2100	2000	600	820	AL
STS82540.189	2100	2000	600	880	AL
STS87540.189	2100	2000	600	920	AL
STS95040.189	2100	2000	600	980	AL
STS100040.189	2100	2000	600	1020	AL
STS112540.189	2100	3000	600	1190	AL
STS125040.189	2100	3000	600	1360	AL
STS137540.189	2100	3000	600	1530	AL
STS150040.189	2100	3000	600	1700	AL

SAH type - with circuit breaker - 189 Hz (p = 7%)

Cat.Nos	Dimensions (mm)			Weight (kg)	Enclosure
	A	B	C		
STS10040.189/DISJ	2100	800	600	200	AL
STS12540.189/DISJ	2100	800	600	220	AL
STS15040.189/DISJ	2100	800	600	240	AL
STS17540.189/DISJ	2100	800	600	260	AL
STS20040.189/DISJ	2100	800	600	280	AL
STS22540.189/DISJ	2100	1600	600	385	AL
STS25040.189/DISJ	2100	1600	600	405	AL
STS27540.189/DISJ	2100	1600	600	430	AL
STS30040.189/DISJ	2100	2000	600	480	AL
STS35040.189/DISJ	2100	2000	600	515	AL
STS40040.189/DISJ	2100	2000	600	550	AL
STS45040.189/DISJ	2100	2000	600	590	AL
STS50040.189/DISJ	2100	2000	600	630	AL
STS52540.189/DISJ	2100	2000	600	650	AL
STS57540.189/DISJ	2100	2000	600	690	AL
STS62540.189/DISJ	2100	2000	600	730	AL
STS70040.189/DISJ	2100	2600	600	790	AL

Dimensions

SAH reinforced type - without circuit breaker - 189 Hz (p = 7%)

Cat.Nos	Dimensions (mm)			Weight (kg)	Enclosure
	A	B	C		
STS.R12040.189	2100	800	500	255	AL
STS.R16040.189	2100	800	500	295	AL
STS.R20040.189	2100	800	500	335	AL
STS.R24040.189	2100	800	500	375	AL
STS.R28040.189	2100	800	500	415	AL
STS.R32040.189	2100	800	500	455	AL
STS.R36040.189	2100	800	500	505	AL
STS.R40040.189	2100	800	500	545	AL
STS.R44040.189	2100	1000	600	600	AL
STS.R48040.189	2100	1000	600	640	AL
STS.R52040.189	2100	2000	600	805	AL
STS.R56040.189	2100	2000	600	845	AL
STS.R60040.189	2100	2000	600	885	AL
STS.R68040.189	2100	2000	600	965	AL
STS.R72040.189	2100	2000	600	1005	AL
STS.R80040.189	2100	2000	600	1085	AL
STS.R84040.189	2100	2000	600	1125	AL
STS.R92040.189	2100	2000	600	1245	AL
STS.R96040.189	2100	2000	600	1285	AL
STS.R108040.189	2100	3000	600	1475	AL
STS.R120040.189	2100	3000	600	1595	AL
STS.R132040.189	2100	3000	600	1715	AL
STS.R144040.189	2100	3000	600	1835	AL

SAH reinforced type - with circuit breaker - 189 Hz (p = 7%)

Cat.Nos	Dimensions (mm)			Weight (kg)	Enclosure
	A	B	C		
STS.R12040.189/DISJ	2100	800	500	260	AL
STS.R16040.189/DISJ	2100	800	500	300	AL
STS.R20040.189/DISJ	2100	800	500	340	AL
STS.R24040.189/DISJ	2100	1600	500	465	AL
STS.R28040.189/DISJ	2100	1600	500	505	AL
STS.R32040.189/DISJ	2100	1600	500	545	AL
STS.R36040.189/DISJ	2100	1600	500	585	AL
STS.R40040.189/DISJ	2100	1600	500	625	AL
STS.R44040.189/DISJ	2100	2000	600	730	AL
STS.R48040.189/DISJ	2100	2000	600	770	AL
STS.R52040.189/DISJ	2100	2000	600	810	AL
STS.R56040.189/DISJ	2100	2000	600	850	AL
STS.R60040.189/DISJ	2100	2000	600	890	AL
STS.R68040.189/DISJ	2100	2600	600	970	AL

SAH extra-reinforced type - without circuit breaker - 215 Hz (p = 5.41%)

Cat.Nos	Dimensions (mm)			Weight (kg)	Enclosure
	A	B	C		
STS.RS14440.215	2100	1000	600	525	AL
STS.RS21640.215	2100	1000	600	610	AL
STS.RS28840.215	2100	1000	600	695	AL
STS.RS36040.215	2100	2000	600	890	AL
STS.RS43240.215	2100	2000	600	975	AL
STS.RS50440.215	2100	2000	600	1060	AL
STS.RS57640.215	2100	2000	600	1145	AL
STS.RS64840.215	2100	3000	600	1340	AL
STS.RS72040.215	2100	3000	600	1425	AL
STS.RS79240.215	2100	3000	600	1510	AL
STS.RS86440.215	2100	3000	600	1595	AL

SAH extra-reinforced type with circuit breaker - 215 Hz (p = 5.41%)

Cat.Nos	Dimensions (mm)			Weight (kg)	Enclosure
	A	B	C		
STS.RS14440.215/DISJ	2100	1000	600	530	AL
STS.RS21640.215/DISJ	2100	1000	600	615	AL
STS.RS28840.215/DISJ	2100	1000	600	745	AL
STS.RS36040.215/DISJ	2100	2000	600	895	AL
STS.RS43240.215/DISJ	2100	2000	600	980	AL
STS.RS50440.215/DISJ	2100	2000	600	1120	AL
STS.RS57640.215/DISJ	2100	2000	600	1205	AL



Selection guide: connection cable cross-section and protective circuit breakers for capacitor banks

THREE-PHASE 400 V CAPACITOR NOMINAL POWER (kVAr)	CABLES MIN. CROSS-SECTION/PHASE		3P THERMAL-MAGNETIC CIRCUIT-BREAKER		
	CU (mm ²)	AL (mm ²)	RANGE	RATING/THERMAL SETTING (A)	
10	6	10	DPX ³ 160 	20/20	
20	10	16		40/40	
30	16	25		63/60	
40	25	35		80/80	
50	35	50		100/100	
60	35	50		125/125	
70	35	50		160/140	
80	50	70		160/160	
90	50	70	DPX ³ 250 	200/180	
100	70	95		200/200	
125	70	95		250/250	
150	95	120	DPX ³ 630 	400/300	
175	120	185		400/350	
200	150	240		400/400	
225	150	240		630/450	
250	185	2 x 120		630/500	
275	185	2 x 120		630/550	
300	2 x 95	2 x 150		630/600	
325	2 x 95	2 x 150		630/630	
350	2 x 120	2 x 185		800/700	
375	2 x 120	2 x 185		800/750	
400	2 x 150	2 x 240	DPX ³ 1600 	800/800	
450	2 x 150	2 x 240		1000/900	
500	2 x 185	4 x 150		1000/1000	
550	2 x 185	4 x 150		1250/1100	
600	4 x 120	4 x 185		1250/1200	
650	4 x 120	4 x 185		1250/1250	
700	4 x 150	4 x 240		1600/1400	
750	4 x 150	4 x 240		1600/1500	
800	4 x 150	4 x 240		1600/1600	
850	4 x 150	4 x 240		2000/1700	
900	4 x 150	4 x 240	DMX ³ 	2000/1800	
950	4 x 185	4 x 300		2000/1900	
1000	4 x 185	4 x 300		2000/2000	

NB: The cable cross-sections given in this table are minimum recommended cross-sections. They do not take additional correction factors into account (method of installation, temperature, long lengths, etc.). The calculations are for single-pole cables fitted at an ambient temperature of 30°C.

CTX³ power contactors - 3-pole for maintenance of Alpmatic racks and enclosures

BREAKING CAPACITY

	25 KA	36 KA	50 KA	70 KA	100 KA
4 200 41	4 200 81	4 201 21	-	-	
4 200 42	4 200 82	4 201 22	-	-	
4 200 43	4 200 83	4 201 23	-	-	
4 200 44	4 200 84	4 201 24	-	-	
4 200 45	4 200 85	4 201 25	-	-	
4 200 46	4 200 86	4 201 26	-	-	
4 200 47	4 200 87	4 201 27	-	-	
4 200 47	4 200 87	4 201 27	-	-	
4 202 08	4 202 38	4 202 68	4 206 08	-	
4 202 08	4 202 38	4 202 68	4 206 08	-	
4 202 09	4 202 39	4 202 69	4 206 09	-	
-	4 220 01	-	4 220 29	4 220 43	
-	4 220 02	-	4 220 30	4 220 44	
-	4 220 02	-	4 220 30	4 220 44	
-	4 220 03	-	4 220 31	4 220 45	
-	4 220 03	-	4 220 31	4 220 45	
-	4 220 04	-	4 220 32	4 220 46	
-	4 220 04	-	4 220 32	4 220 46	
-	4 220 04	-	4 220 32	4 220 46	
-	-	4 222 64	4 222 76	-	
-	-	4 222 64	4 222 76	-	
-	-	4 222 64	4 222 76	-	
-	-	4 222 65	4 222 77	-	
-	-	4 222 65	4 222 77	-	
-	-	4 222 66	4 222 78	-	
-	-	4 222 66	4 222 78	-	
-	-	4 222 66	4 222 78	-	

The DMX³ range is available in the Legrand catalogue
If you have any questions, please consult us

Contactor selection according to the step power ratings

Step power ratings at 400 V (kVar)	Capacitor banks without detuned reactor With Alpviv ³ capacitors - 3 single-phase (Δ configuration)	
	Screw terminals	Cage terminals
5	4 161 19 + 4 168 74	-
10		
12.5		
15		
20		
25		
30	-	4 162 59 + 4 168 76
35		
40		
45		
50		
60	-	4 161 99 + 4 168 76
70		
75		
80	-	4 162 39 + 4 168 76

Step power ratings at 400 V (kVar)	Capacitor banks with detuned reactor With Alpviv ³ capacitors - 3 single-phase (Δ configuration)	
	Screw terminals	Cage terminals
5	4 161 19	4 161 59
10		
12.5		
15		
20		
25		
30	4 161 39	4 161 59
35		
40		
45		
50		
60	-	4 161 79
70		
75		
80	-	4 162 59

For direct control of three-phase Alpviv³ capacitors or other power ratings, please consult us

Alpivar³ capacitors

selection table

Rated voltage (V)	Nominal power at 50 Hz (kVAr)	Capacitor type		
		Three-phase capacitors without terminal cover	Three-phase capacitors with terminal cover	3 single-phase capacitors
230 V~	2.5	V2.523	V2.523CB	V2.523-3MONO
	5	V523	V523CB	V523-3MONO
	10	V1023	V1023CB	V1023-3MONO
	15	V1523	V1523CB	V1523-3MONO
	20	V2023	V2023CB	V2023-3MONO
	25	V2523	V2523CB	V2523-3MONO
	30	V3023	V3023CB	V3023-3MONO
	40	V4023	V4023CB	V4023-3MONO
	50	V5023	V5023CB	V5023-3MONO
400 V~ S type	60	V6023	V6023CB	V6023-3MONO
	2.5	V2.540	V2.540CB	V2.540-3MONO
	5	V540	V540CB	V540-3MONO
	6.25	V6.2540	V6.2540CB	V6.2540-3MONO
	7.5	V7.540	V7.540CB	V7.540-3MONO
	10	V1040	V1040CB	V1040-3MONO
	12.5	V12.540	V12.540CB	V12.540-3MONO
	15	V1540	V1540CB	V1540-3MONO
	20	V2040	V2040CB	V2040-3MONO
	25	V2540	V2540CB	V2540-3MONO
	30	V3040	V3040CB	V3040-3MONO
	35	V3540	V3540CB	V3540-3MONO
	40	V4040	V4040CB	V4040-3MONO
	50	V5040	V5040CB	V5040-3MONO
	60	V6040	V6040CB	V6040-3MONO
	75	V7540	V7540CB	V7540-3MONO
	80	V8040	V8040CB	V8040-3MONO
90	V9040	V9040CB	V9040-3MONO	
100	V10040	V10040CB	V10040-3MONO	
125	V12540	V12540CB	V12540-3MONO	
400 V~ H type	2.5	VH2.540	VH2.540CB	VH2.540-3MONO
	5	VH540	VH540CB	VH540-3MONO
	6.25	VH6.2540	VH6.2540CB	VH6.2540-3MONO
	7.5	VH7.540	VH7.540CB	VH7.540-3MONO
	10	VH1040	VH1040CB	VH1040-3MONO
	12.5	VH12.540	VH12.540CB	VH12.540-3MONO
	15	VH1540	VH1540CB	VH1540-3MONO
	20	VH2040	VH2040CB	VH2040-3MONO
	25	VH2540	VH2540CB	VH2540-3MONO
	30	VH3040	VH3040CB	VH3040-3MONO
	35	VH3540	VH3540CB	VH3540-3MONO
	40	VH4040	VH4040CB	VH4040-3MONO
	50	VH5040	VH5040CB	VH5040-3MONO
	60	VH6040	VH6040CB	VH6040-3MONO
	75	VH7540	VH7540CB	VH7540-3MONO
	80	VH8040	VH8040CB	VH8040-3MONO
	90	VH9040	VH9040CB	VH9040-3MONO
100	VH10040	VH10040CB	VH10040-3MONO	
125	VH12540	VH12540CB	VH12540-3MONO	

Alpivar³ capacitors

selection table (continued)

Rated voltage (V)	Nominal power at 50 Hz (kVAR)	Capacitor type		
		Three-phase capacitors without terminal cover	Three-phase capacitors with terminal cover	3 single-phase capacitors
440 V~	3	V344	V344CB	V344-3MONO
	5	V544	V544CB	V544-3MONO
	6.25	V6.2544	V6.2544CB	V6.2544-3MONO
	7.5	V7.544	V7.544CB	V7.544-3MONO
	12.5	V12.544	V12.544CB	V12.544-3MONO
	15	V1544	V1544CB	V1544-3MONO
	20	V2044	V2044CB	V2044-3MONO
	25	V2544	V2544CB	V2544-3MONO
	30	V3044	V3044CB	V3044-3MONO
	40	V4044	V4044CB	V4044-3MONO
	50	V5044	V5044CB	V5044-3MONO
	60	V6044	V6044CB	V6044-3MONO
	70	V7044	V7044CB	V7044-3MONO
	75	V7544	V7544CB	V7544-3MONO
	80	V8044	V8044CB	V8044-3MONO
	90	V9044	V9044CB	V9044-3MONO
	100	V10044	V10044CB	V10044-3MONO
120	V12044	V12044CB	V12044-3MONO	
125	V12544	V12544CB	V12544-3MONO	
150	V15044	V15044CB	V15044-3MONO	
525 V~	10	V1052	V1052CB	V1052-3MONO
	12.5	V12.552	V12.552CB	V12.552-3MONO
	20	V2052	V2052CB	V2052-3MONO
	25	V2552	V2552CB	V2552-3MONO
	30	V3052	V3052CB	V3052-3MONO
	40	V4052	V4052CB	V4052-3MONO
	50	V5052	V5052CB	V5052-3MONO
	60	V6052	V6052CB	V6052-3MONO
	70	V7052	V7052CB	V7052-3MONO
	80	V8052	V8052CB	V8052-3MONO
	85	V8552	V8552CB	V8552-3MONO
	90	V9052	V9052CB	V9052-3MONO
	100	V10052	V10052CB	V10052-3MONO
125	V12552	V12552CB	V12552-3MONO	
690 V~	10	V1069	V1069CB	-
	20	V2069	V2069CB	-
	30	V3069	V3069CB	-
	40	V4069	V4069CB	-
	50	V5069	V5069CB	-
	60	V6069	V6069CB	-
	70	V7069	V7069CB	-
	80	V8069	V8069CB	-
	90	V9069	V9069CB	-
100	V10069	V10069CB	-	



V7540CB



Technical characteristics p. 39-44

Double or class II insulation. Totally dry
Self-extinguishing polyurethane resin casing. Internal protection for each winding using:

- a self-healing metallised polypropylene film
- an electrical fuse
- a disconnection device in case of a pressure surge
- Colour: casing RAL 7032
cover RAL 7035

Conforming to standard IEC 60831-1 and 2

Pack	Cat.Nos		Nominal power (kVAr)
	Without terminal cover	With terminal cover	
			Max. harmonic pollution level THDU ≤ 3%, THDI ≤ 10%
1	V2.540	V2.540CB	2.5
1	V540	V540CB	5
1	V6.2540	V6.2540CB	6.25
1	V7.540	V7.540CB	7.5
1	V1040	V1040CB	10
1	V12.540	V12.540CB	12.5
1	V1540	V1540CB	15
1	V2040	V2040CB	20
1	V2540	V2540CB	25
1	V3040	V3040CB	30
1	V3540	V3540CB	35
1	V4040	V4040CB	40
1	V5040	V5040CB	50
1	V6040	V6040CB	60
1	V7540	V7540CB	75
1	V8040	V8040CB	80
1	V9040	V9040CB	90
1	V10040	V10040CB	100
1	V12540	V12540CB	125

Pack	Cat.Nos	Nominal power (kVAr)
	3 single-phase capacitors - S type	
	Max. harmonic pollution level THDU ≤ 3%, THDI ≤ 10%	
1	V2.540-3MONO	2.5
1	V540-3MONO	5
1	V6.2540-3MONO	6.25
1	V7.540-3MONO	7.5
1	V1040-3MONO	10
1	V12.540-3MONO	12.5
1	V1540-3MONO	15
1	V2040-3MONO	20
1	V2540-3MONO	25
1	V3040-3MONO	30
1	V3540-3MONO	35
1	V4040-3MONO	40
1	V5040-3MONO	50
1	V6040-3MONO	60
1	V7540-3MONO	75
1	V8040-3MONO	80
1	V9040-3MONO	90
1	V10040-3MONO	100
1	V12540-3MONO	125

Pack	Cat.Nos		Nominal power (kVAr)
	Without terminal cover	With terminal cover	
			Max. harmonic pollution level THDU ≤ 4%, THDI ≤ 15%
1	VH2.540	VH2.540CB	2.5
1	VH540	VH540CB	5
1	VH6.2540	VH6.2540CB	6.25
1	VH7.540	VH7.540CB	7.5
1	VH1040	VH1040CB	10
1	VH12.540	VH12.540CB	12.5
1	VH1540	VH1540CB	15
1	VH2040	VH2040CB	20
1	VH2540	VH2540CB	25
1	VH3040	VH3040CB	30
1	VH3540	VH3540CB	35
1	VH4040	VH4040CB	40
1	VH5040	VH5040CB	50
1	VH6040	VH6040CB	60
1	VH7540	VH7540CB	75
1	VH8040	VH8040CB	80
1	VH9040	VH9040CB	90
1	VH10040	VH10040CB	100
1	VH12540	VH12540CB	125

Pack	Cat.Nos	Nominal power (kVAr)
	3 single-phase capacitors - H type	
	Max. harmonic pollution level THDU ≤ 4%, THDI ≤ 15%	
1	VH2.540-3MONO	2.5
1	VH540-3MONO	5
1	VH6.2540-3MONO	6.25
1	VH7.540-3MONO	7.5
1	VH1040-3MONO	10
1	VH12.540-3MONO	12.5
1	VH1540-3MONO	15
1	VH2040-3MONO	20
1	VH2540-3MONO	25
1	VH3040-3MONO	30
1	VH3540-3MONO	35
1	VH4040-3MONO	40
1	VH5040-3MONO	50
1	VH6040-3MONO	60
1	VH7540-3MONO	75
1	VH8040-3MONO	80
1	VH9040-3MONO	90
1	VH10040-3MONO	100
1	VH12540-3MONO	125

Alpivar³ capacitors

technical characteristics

Technical specifications

Discharge resistors

Fitted inside (except by special request), these discharge the unit in accordance with current standards (discharge time, 3 minutes)

Loss factor

Alpivar³ capacitors have a loss factor of less than 0.1×10^{-3} . This value leads to a power consumption of less than 0.3 W per kVar, including the discharge resistors

Capacitance

Tolerance on the capacitance value: $\pm 5\%$
Excellent stability of the capacitance throughout the service life of the Alpivar³ capacitor

Permissible overvoltage:

$1.18 \times U$, 12/24 hrs

Permissible overcurrent:

- S type: up to $1.5 \times I_n$
- H type: up to $2 \times I_n$

Mounting position:

indoors, vertical or horizontal

Current peak withstand:

- S type: up to $250 \times I_n$
- H type: up to $350 \times I_n$

Max. number of switching operations per year:

- S type: up to 30,000
- H type: up to 65,000

Average service life:

- S type: up to 130,000 hrs
- H type: up to 170,000 hrs

Insulation class

- 50 Hz withstand for 1 min: 6 kV
- 1.2/50 μ s impulse withstand: 25 kV

Dimensions

All capacitor types

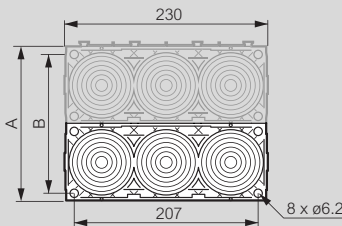

Three-phase capacitors without terminal cover

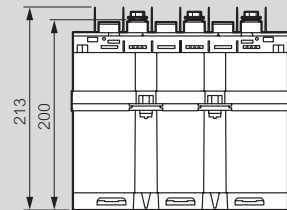

Three-phase capacitors with terminal cover

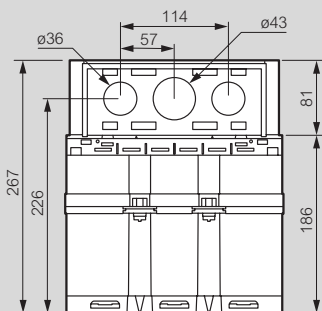

3 single-phase capacitors

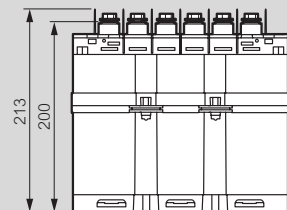

Rated voltage 230 V~

Capacitor type			Number of modules	Dimensions (mm)		Weight (kg)
Three-phase without terminal cover	Three-phase with terminal cover	3 single-phase		A	B	
V2.523	V2.523CB	V2.523-3MONO	1	93	70	3.5
V523	V523CB	V523-3MONO	1	93	70	3.5
V1023	V1023CB	V1023-3MONO	1	93	70	3.5
V1523	V1523CB	V1523-3MONO	2	180	157	7
V2023	V2023CB	V2023-3MONO	2	180	157	7
V2523	V2523CB	V2523-3MONO	3	267	244	10.5
V3023	V3023CB	V3023-3MONO	3	267	244	10.5
V4023	V4023CB	V4023-3MONO	4	354	331	14
V5023	V5023CB	V5023-3MONO	5	441	418	17.5
V6023	V6023CB	V6023-3MONO	6	528	505	21

Rated voltage 400 V~

Capacitor type			Number of modules	Dimensions (mm)		Weight (kg)
Three-phase without terminal cover	Three-phase with terminal cover	3 single-phase		A	B	
S type capacitors						
V2.540	V2.540CB	V2.540-3MONO	1	93	70	3.5
V540	V6.2540CB	V540-3MONO	1	93	70	3.5
V6.2540	V540CB	V6.2540-3MONO	1	93	70	3.5
V7.540	V7.540CB	V7.540-3MONO	1	93	70	3.5
V1040	V1040CB	V1040-3MONO	1	93	70	3.5
V12.540	V12.540CB	V12.540-3MONO	1	93	70	3.5
V1540	V1540CB	V1540-3MONO	1	93	70	3.5
V2040	V2040CB	V2040-3MONO	1	93	70	3.5
V2540	V2540CB	V2540-3MONO	1	93	70	3.5
V3040	V3040CB	V3040-3MONO	2	180	157	7
V3540	V3540CB	V3540-3MONO	2	180	157	7
V4040	V4040CB	V4040-3MONO	2	180	157	7
V5040	V5040CB	V5040-3MONO	2	180	157	7
V6040	V6040CB	V6040-3MONO	3	267	244	10.5
V7540	V7540CB	V7540-3MONO	3	267	244	10.5
V8040	V8040CB	V8040-3MONO	4	354	331	14
V9040	V9040CB	V9040-3MONO	4	354	331	14
V10040	V10040CB	V10040-3MONO	4	354	331	14
V12540	V12540CB	V12540-3MONO	5	441	418	17.5
H type capacitors						
VH2.540	VH2.540CB	VH2.540-3MONO	1	93	70	3.5
VH540	VH540CB	VH540-3MONO	1	93	70	3.5
VH6.2540	VH6.2540CB	VH6.2540-3MONO	1	93	70	3.5
VH7.540	VH7.540CB	VH7.540-3MONO	1	93	70	3.5
VH1040	VH1040CB	VH1040-3MONO	1	93	70	3.5
VH12.540	VH12.540CB	VH12.540-3MONO	1	93	70	3.5
VH1540	VH1540CB	VH1540-3MONO	1	93	70	3.5
VH2040	VH2040CB	VH2040-3MONO	1	93	70	3.5
VH2540	VH2540CB	VH2540-3MONO	1	93	70	3.5
VH3040	VH3040CB	VH3040-3MONO	2	180	157	7
VH3540	VH3540CB	VH3540-3MONO	2	180	157	7
VH4040	VH4040CB	VH4040-3MONO	2	180	157	7
VH5040	VH5040CB	VH5040-3MONO	2	180	157	7
VH6040	VH6040CB	VH6040-3MONO	3	267	244	10.5
VH7540	VH7540CB	VH7540-3MONO	3	267	244	10.5
VH8040	VH8040CB	VH8040-3MONO	4	354	331	14
VH9040	VH9040CB	VH9040-3MONO	4	354	331	14
VH10040	VH10040CB	VH10040-3MONO	4	354	331	14
VH12540	VH12540CB	VH12540-3MONO	5	441	418	17.5

Alpivar³ capacitors

technical characteristics (continued)

■ Dimensions (continued)

Rated voltage 440 V \sim

Capacitor type			Number of modules	Dimensions (mm)		Weight (kg)
Three-phase without terminal cover	Three-phase with terminal cover	3 single-phase		A	B	
V344	V344CB	V344-3MONO	1	93	70	3.5
V544	V544CB	V544-3MONO	1	93	70	3.5
V6.2544	V6.2544CB	V6.2544-3MONO	1	93	70	3.5
V7.544	V7.544CB	V7.544-3MONO	1	93	70	3.5
V12.544	V12.544CB	V12.544-3MONO	1	93	70	3.5
V1544	V1544CB	V1544-3MONO	1	93	70	3.5
V2044	V2044CB	V2044-3MONO	1	93	70	3.5
V2544	V2544CB	V2544-3MONO	1	93	70	3.5
V3044	V3044CB	V3044-3MONO	1	93	70	3.5
V4044	V4044CB	V4044-3MONO	2	180	157	7
V5044	V5044CB	V5044-3MONO	2	180	157	7
V6044	V6044CB	V6044-3MONO	2	180	157	7
V7044	V7044CB	V7044-3MONO	3	267	244	10.5
V7544	V7544CB	V7544-3MONO	3	267	244	10.5
V8044	V8044CB	V8044-3MONO	3	267	244	10.5
V9044	V9044CB	V9044-3MONO	3	267	244	10.5
V10044	V10044CB	V10044-3MONO	4	354	331	14
V12044	V12044CB	V12044-3MONO	5	441	418	17.5
V12544	V12544CB	V12544-3MONO	5	441	418	17.5
V15044	V15044CB	V15044-3MONO	6	528	505	21

Rated voltage 525 V \sim

Capacitor type			Number of modules	Dimensions (mm)		Weight (kg)
Three-phase without terminal cover	Three-phase with terminal cover	3 single-phase		A	B	
V1052	V1052CB	V1052-3MONO	1	93	70	3.5
V12.552	V12.552CB	V12.552-3MONO	1	93	70	3.5
V2052	V2052CB	V2052-3MONO	1	93	70	3.5
V2552	V2552CB	V2552-3MONO	1	93	70	3.5
V3052	V3052CB	V3052-3MONO	2	180	157	7
V4052	V4052CB	V4052-3MONO	2	180	157	7
V5052	V5052CB	V5052-3MONO	2	180	157	7
V6052	V6052CB	V6052-3MONO	3	267	244	10.5
V7052	V7052CB	V7052-3MONO	3	267	244	10.5
V8052	V8052CB	V8052-3MONO	4	354	331	14
V8552	V8552CB	V8552-3MONO	4	354	331	14
V9052	V9052CB	V9052-3MONO	4	354	331	14
V10052	V10052CB	V10052-3MONO	4	354	331	14
V12552	V12552CB	V12552-3MONO	5	441	418	17.5

Rated voltage 690 V \sim

Capacitor type			Number of modules	Dimensions (mm)		Weight (kg)
Three-phase without terminal cover	Three-phase with terminal cover			A	B	
V1069	V1069CB		1	93	70	3.5
V2069	V2069CB		1	93	70	3.5
V3069	V3069CB		1	93	70	3.5
V4069	V4069CB		1	93	70	3.5
V5069	V5069CB		2	180	157	7
V6069	V6069CB		2	180	157	7
V7069	V7069CB		2	180	157	7
V8069	V8069CB		3	267	244	10.5
V9069	V9069CB		3	267	244	10.5
V10069	V10069CB		4	354	331	14
V8552	V8552CB		4	354	331	14
V9052	V9052CB		4	354	331	14
V10052	V10052CB		4	354	331	14

Alpivar³ capacitors

technical characteristics (continued)

■ CTX³ contactors and HRC cartridge fuses selection for capacitors without detuned reactors

Network 400 V - 50 Hz

Max. harmonic pollution THDU ≤ 3 % ; THDI ≤ 10 %

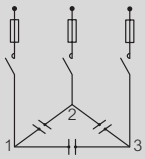
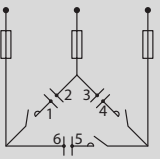
Effective power at 400 V (kVAr)	Alpivar ³ capacitors Cat.Nos	CTX ³ contactors and switching units			HRC fuses gG In	Effective power at 400 V (kVAr)	Alpivar ³ capacitors Cat.Nos	CTX ³ contactors and switching units			HRC fuses gG In
		Coil voltage	Screw terminals	Cage terminals				Coil voltage	Screw terminals	Cage terminals	
Three-phase capacitors S type 					3 single-phase capacitors S type 						
6.25	V6.2540	24 V~	4 160 80 + 4 168 74	-	16 A	12.5	V12.540-3MONO	24 V~	4 160 90 + 4 168 74	-	25 A
		24 V=	4 160 81 + 4 168 74	-				24 V=	4 160 91 + 4 168 74	-	
		48 V~	4 160 82 + 4 168 74	-				48 V~	4 160 92 + 4 168 74	-	
		48 V=	4 160 83 + 4 168 74	-				48 V=	4 160 93 + 4 168 74	-	
		110 V~	4 160 84 + 4 168 74	-				110 V~	4 160 94 + 4 168 74	-	
		230 V~	4 160 86 + 4 168 74	-				230 V~	4 160 96 + 4 168 74	-	
		380 V~	4 160 88 + 4 168 74	-				380 V~	4 160 98 + 4 168 74	-	
12.5	V12.540	415 V~	4 160 89 + 4 168 74	-	25 A	25	V2540-3MONO	24 V~	4 161 10 + 4 168 74	-	50 A
		24 V=	4 160 91 + 4 168 74	-				24 V=	4 161 11 + 4 168 74	-	
		48 V~	4 160 92 + 4 168 74	-				48 V~	4 161 12 + 4 168 74	-	
		48 V=	4 160 93 + 4 168 74	-				48 V=	4 161 13 + 4 168 74	-	
		110 V~	4 160 94 + 4 168 74	-				110 V~	4 161 14 + 4 168 74	-	
		230 V~	4 160 96 + 4 168 74	-				230 V~	4 161 16 + 4 168 74	-	
		380 V~	4 160 98 + 4 168 74	-				380 V~	4 161 18 + 4 168 74	-	
25	V2540	415 V~	4 160 99 + 4 168 74	-	50 A	50	V5040-3MONO	24 V~	4 161 40 + 4 168 75	4 161 50 + 4 168 76	100 A
		24 V=	4 161 21 + 4 168 74	-				24 V=	4 161 41 + 4 168 75	4 161 51 + 4 168 76	
		48 V~	4 161 22 + 4 168 74	-				48 V~	4 161 42 + 4 168 75	4 161 52 + 4 168 76	
		48 V=	4 161 23 + 4 168 74	-				48 V=	4 161 42 + 4 168 75	4 161 53 + 4 168 76	
		110 V~	4 161 24 + 4 168 74	-				110 V~	4 161 44 + 4 168 75	4 161 54 + 4 168 76	
		230 V~	4 161 26 + 4 168 74	-				230 V~	4 161 46 + 4 168 75	4 161 56 + 4 168 76	
		380 V~	4 161 28 + 4 168 74	-				380 V~	4 161 48 + 4 168 75	4 161 58 + 4 168 76	
50	V5040	415 V~	4 161 29 + 4 168 74	-	100 A	75	V7540-3MONO	24 V~	4 161 80 + 4 168 77	4 161 90 + 4 168 76	160 A
		24 V=	4 161 81 + 4 168 77	4 161 91 + 4 168 76				24 V=	4 161 81 + 4 168 77	4 161 91 + 4 168 76	
		48 V~	4 161 82 + 4 168 77	4 161 92 + 4 168 76				48 V~	4 161 82 + 4 168 77	4 161 92 + 4 168 76	
		48 V=	4 161 83 + 4 168 77	4 161 93 + 4 168 76				48 V=	4 161 83 + 4 168 77	4 161 93 + 4 168 76	
		110 V~	4 161 84 + 4 168 77	4 161 94 + 4 168 76				110 V~	4 161 84 + 4 168 77	4 161 94 + 4 168 76	
		230 V~	4 161 86 + 4 168 77	4 161 96 + 4 168 76				230 V~	4 161 86 + 4 168 77	4 161 96 + 4 168 76	
		380 V~	4 161 88 + 4 168 77	4 161 98 + 4 168 76				380 V~	4 161 88 + 4 168 77	4 161 98 + 4 168 76	
		415 V~	4 161 89 + 4 168 77	4 161 99 + 4 168 76			415 V~	4 161 89 + 4 168 77	4 161 99 + 4 168 76		



Alpivar³ capacitors

technical characteristics (continued)

CTX³ contactors and HRC cartridge fuses selection for capacitors without detuned reactors (continued)

Network 400 V - 50 Hz

Max. harmonic pollution THDU ≤ 4 % ; THDI ≤ 15 %

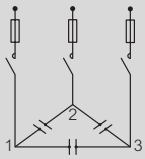
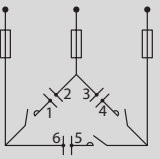
Effective power at 400 V (kVAr)	Alpivar ³ capacitors Cat.Nos	CTX ³ contactors and switching units			HRC fuses gG In	Effective power at 400 V (kVAr)	Alpivar ³ capacitors Cat.Nos	CTX ³ contactors and switching units			HRC fuses gG In
		Coil voltage	Screw terminals	Cage terminals				Coil voltage	Screw terminals	Cage terminals	
Three-phase capacitors H type 					3 single-phase capacitors S type 						
6.25	VH6.2540	24 V~	4 160 80 + 4 168 74	-	16 A	12.5	VH12.540-3MONO	24 V~	4 160 90 + 4 168 74	-	25 A
		24 V=	4 160 81 + 4 168 74	-				24 V=	4 160 91 + 4 168 74	-	
		48 V~	4 160 82 + 4 168 74	-				48 V~	4 160 92 + 4 168 74	-	
		48 V=	4 160 83 + 4 168 74	-				48 V=	4 160 93 + 4 168 74	-	
		110 V~	4 160 84 + 4 168 74	-				110 V~	4 160 94 + 4 168 74	-	
		230 V~	4 160 86 + 4 168 74	-				230 V~	4 160 96 + 4 168 74	-	
		380 V~	4 160 88 + 4 168 74	-				380 V~	4 160 98 + 4 168 74	-	
12.5	VH12.540	415 V~	4 160 89 + 4 168 74	-	25 A	25	VH2540-3MONO	24 V~	4 161 10 + 4 168 74	-	50 A
		24 V=	4 160 91 + 4 168 74	-				24 V=	4 161 11 + 4 168 74	-	
		48 V~	4 160 92 + 4 168 74	-				48 V~	4 161 12 + 4 168 74	-	
		48 V=	4 160 93 + 4 168 74	-				48 V=	4 161 13 + 4 168 74	-	
		110 V~	4 160 94 + 4 168 74	-				110 V~	4 161 14 + 4 168 74	-	
		230 V~	4 160 96 + 4 168 74	-				230 V~	4 161 16 + 4 168 74	-	
		380 V~	4 160 98 + 4 168 74	-				380 V~	4 161 18 + 4 168 74	-	
25	VH2540	415 V~	4 160 99 + 4 168 74	-	50 A	50	VH5040-3MONO	24 V~	4 161 40 + 4 168 75	4 161 50 + 4 168 76	100 A
		24 V=	4 161 21 + 4 168 74	-				24 V=	4 161 41 + 4 168 75	4 161 51 + 4 168 76	
		48 V~	4 161 22 + 4 168 74	-				48 V~	4 161 42 + 4 168 75	4 161 52 + 4 168 76	
		48 V=	4 161 23 + 4 168 74	-				48 V=	4 161 42 + 4 168 75	4 161 53 + 4 168 76	
		110 V~	4 161 24 + 4 168 74	-				110 V~	4 161 44 + 4 168 75	4 161 54 + 4 168 76	
		230 V~	4 161 26 + 4 168 74	-				230 V~	4 161 46 + 4 168 75	4 161 56 + 4 168 76	
		380 V~	4 161 28 + 4 168 74	-				380 V~	4 161 48 + 4 168 75	4 161 58 + 4 168 76	
50	VH5040	415 V~	4 161 29 + 4 168 74	-	100 A	75	VH7540-3MONO	24 V~	4 161 80 + 4 168 77	4 161 90 + 4 168 76	160 A
		24 V=	4 161 81 + 4 168 77	4 161 91 + 4 168 76				24 V=	4 161 81 + 4 168 77	4 161 91 + 4 168 76	
		48 V~	4 161 82 + 4 168 77	4 161 92 + 4 168 76				48 V~	4 161 82 + 4 168 77	4 161 92 + 4 168 76	
		48 V=	4 161 83 + 4 168 77	4 161 93 + 4 168 76				48 V=	4 161 83 + 4 168 77	4 161 93 + 4 168 76	
		110 V~	4 161 84 + 4 168 77	4 161 94 + 4 168 76				110 V~	4 161 84 + 4 168 77	4 161 94 + 4 168 76	
		230 V~	4 161 86 + 4 168 77	4 161 96 + 4 168 76				230 V~	4 161 86 + 4 168 77	4 161 96 + 4 168 76	
		380 V~	4 161 88 + 4 168 77	4 161 98 + 4 168 76				380 V~	4 161 88 + 4 168 77	4 161 98 + 4 168 76	
		415 V~	4 161 89 + 4 168 77	4 161 99 + 4 168 76			415 V~	4 161 89 + 4 168 77	4 161 99 + 4 168 76		

Alpivar³ capacitors

technical characteristics (continued)

CTX³ contactors and HRC cartridge fuses selection for capacitors with detuned reactors

Network 400 V - 50 Hz

Max. harmonic pollution THDU ≤ 6 % ; THDI ≤ 30 %

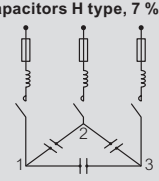
Effective power at 400 V (kVAr)	Alpivar ³ capacitors Cat.Nos	Detuned reactor 189 Hz (p = 7%) Cat.Nos	CTX ³ contactors and switching units		HRC fuses gG In
			Coil voltage	Screw terminals / Cage terminals	
Three-phase capacitors H type, 7 % detuned reactor 					
12.5	VH12.540	SAH2.85-21.0A	24 V~	4 161 00	25 A
			24 V=	4 161 01	
			48 V~	4 161 02	
			48 V=	4 161 03	
			110 V~	4 161 04	
			230 V~	4 161 06	
			380 V~	4 161 08	
25	VH2540	SAH1.45-42.0A	415 V~	4 161 09	50 A
			24 V~	4 161 30	
			24 V=	4 161 31	
			48 V~	4 161 32	
			48 V=	4 161 33	
			110 V~	4 161 34	
			230 V~	4 161 36	
50	VH5040	SAH0.72-83.0A	380 V~	4 161 38	100 A
			415 V~	4 161 39	
			24 V~	4 161 80 / 4 161 90	
			24 V=	4 161 81 / 4 161 91	
			48 V~	4 161 82 / 4 161 92	
			48 V=	4 161 83 / 4 161 93	
			110 V~	4 161 84 / 4 161 94	
75	VH7540	SAH0.48-123.0A	230 V~	4 161 86 / 4 161 96	160 A
			380 V~	4 161 88 / 4 161 98	
			415 V~	4 161 89 / 4 161 99	
			24 V~	4 162 40 / 4 162 50	
			24 V=	4 162 41 / 4 162 51	
			48 V~	4 162 42 / 4 162 52	
			48 V=	4 162 43 / 4 162 53	
100-240 V~/=	4 162 46 / 4 162 56				
400-440 V~	4 162 49 / 4 162 59				

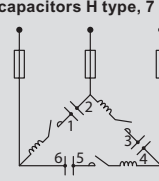
Effective power at 400 V (kVAr)	Alpivar ³ capacitors Cat.Nos	Detuned reactor 189 Hz (p = 7%) Cat.Nos	CTX ³ contactors and switching units		HRC fuses gG In
			Coil voltage	Screw terminals / Cage terminals	
3 single-phase capacitors H type, 7 % detuned reactor 					
25	VH2540-3MONO	SAH4.30-25.1A	110 V~	4 161 04	50 A
			230 V~	4 161 06	
			380 V~	4 161 00	
			415 V~	4 161 09	
50	VH5040-3MONO	SAH2.15-50.0A	24 V~	4 161 40 / 4 161 50	100 A
			24 V=	4 161 41 / 4 161 51	
			48 V~	4 161 42 / 4 161 52	
			48 V=	4 161 43 / 4 161 53	
			110 V~	4 161 44 / 4 161 54	
			230 V~	4 161 46 / 4 161 56	
			380 V~	4 161 48 / 4 161 58	
75	VH7540-3MONO	SAH1.44-74.4A	415 V~	4 161 49 / 4 161 59	160 A
			24 V~	4 162 60 / 4 162 70	
			24 V=	4 162 61 / 4 162 71	
			48 V~	4 162 62 / 4 162 72	
			48 V=	4 162 63 / 4 162 73	
			110 V~	4 162 66 / 4 162 74	
			230 V~	4 162 66 / 4 162 76	
			380 V~	4 162 68 / 4 162 78	
			415 V~	4 162 69 / 4 162 79	

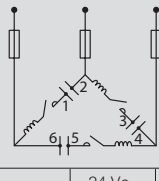
Effective power at 400 V (kVAr)	Alpivar ³ capacitors Cat.Nos	Detuned reactor 135 Hz (p = 14%) Cat.Nos	CTX ³ contactors and switching units		HRC fuses gG In
			Coil voltage	Screw terminals / Cage terminals	
3 single-phase Alpivar³ capacitors 480 V, 14 % detuned reactor 					
17.5	V21.548-3MONO (21.5 kVAr at 480 V)	SAH14.10-16.0A	24 V~	4 161 10	40 A
			24 V=	4 161 11	
			48 V~	4 161 12	
			48 V=	4 161 13	
			110 V~	4 161 14	
			230 V~	4 161 16	
			380 V~	4 161 18	
35	V4348-3MONO (43 kVAr at 480 V)	SAH7.05-31.0A	415 V~	4 161 19	80 A
			24 V~	4 161 40 / 4 161 50	
			24 V=	4 161 41 / 4 161 51	
			48 V~	4 161 42 / 4 161 52	
			48 V=	4 161 43 / 4 161 53	
			110 V~	4 161 44 / 4 161 54	
			230 V~	4 161 46 / 4 161 56	
70	V8640-3MONO (86 kVAr at 480 V)	SAH3.52-62.0A	380 V~	4 161 48 / 4 161 58	160 A
			415 V~	4 161 49 / 4 161 59	
			24 V~	4 162 60 / 4 162 70	
			24 V=	4 162 61 / 4 162 71	
			48 V~	4 162 62 / 4 162 72	
			48 V=	4 162 63 / 4 162 73	
			110 V~	4 162 66 / 4 162 74	
230 V~	4 162 66 / 4 162 76				
380 V~	4 162 68 / 4 162 78				
415 V~	4 162 69 / 4 162 79				

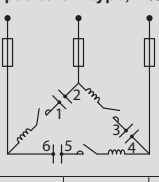
Effective power at 400 V (kVAr)	Alpivar ³ capacitors Cat.Nos	Detuned reactor 189 Hz (p = 7%) Cat.Nos	CTX ³ contactors and switching units		HRC fuses gG In
			Coil voltage	Screw terminals / Cage terminals	
3 single-phase capacitors H type, 7 % detuned reactor 					
12.5	VH12.540-3MONO	SAH8.55-12.6A	24 V~	4 160 90	25 A
			24 V=	4 160 91	
			48 V~	4 160 92	
			48 V=	4 160 93	
			110 V~	4 160 94	
			230 V~	4 160 96	
			380 V~	4 160 98	
25	VH2540-3MONO	SAH4.30-25.1A	415 V~	4 160 99	50 A
			24 V~	4 161 00	
			24 V=	4 161 01	
			48 V~	4 161 02	
48 V=	4 161 03				



Alpivar³ capacitors

technical characteristics (continued)

■ CTX³ contactors and HRC cartridge fuses selection table for capacitors with detuned reactors (continued)

Network 400 V - 50 Hz

Max. harmonic pollution THDU ≤ 8 % ; THDI ≤ 40 %

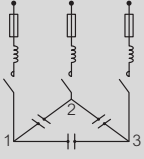
Effective power at 400 V (kVAr)	Alpivar ³ capacitors Cat.Nos	Detuned reactor 189 Hz (p = 7%) Cat.Nos	CTX ³ contactors and switching units		HRC fuses gG In
			Coil voltage	Screw terminals / Cage terminals	
Three-phase capacitors H type, 7 % detuned reactor 					
20	VH2040	SAH1.78-38.0A	24 V~	4 161 20	40 A
			24 V=	4 161 21	
			48 V~	4 161 22	
			48 V=	4 161 23	
			110 V~	4 161 24	
			230 V~	4 161 26	
			380 V~	4 161 28	
415 V~	4 161 29				
40	VH4040	SAH0.90-75.0A	24 V~	4 162 60 / 4 162 70	80 A
			24 V=	4 162 61 / 4 162 71	
			48 V~	4 162 62 / 4 162 72	
			48 V=	4 162 63 / 4 162 73	
			110 V~	4 162 66 / 4 162 74	
			230 V~	4 162 66 / 4 162 76	
			380 V~	4 162 68 / 4 162 78	
415 V~	4 162 69 / 4 162 79				
80	VH8040	SAH0.45-150.0A	24 V~	4 162 40 / 4 162 50	160 A
			24 V=	4 162 41 / 4 162 51	
			48 V~	4 162 42 / 4 162 52	
			48 V=	4 162 43 / 4 162 53	
			100-240 V~/=	4 162 46 / 4 162 56	
			400-440 V~	4 162 49 / 4 162 59	

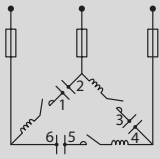
Effective power at 400 V (kVAr)	Alpivar ³ capacitors Cat.Nos	Detuned reactor 189 Hz (p = 7%) Cat.Nos	CTX ³ contactors and switching units		HRC fuses gG In
			Coil voltage	Screw terminals / Cage terminals	
3 single-phase capacitors H type, 7 % detuned reactor 					
10	VH1040-3MONO	SAH10.70-12.0A	24 V~	4 160 90	20 A
			24 V=	4 160 91	
			48 V~	4 160 92	
			48 V=	4 160 93	
			110 V~	4 160 94	
			230 V~	4 160 96	
			380 V~	4 160 98	
415 V~	4 160 99				
20	VH2040-3MONO	SAH5.36-23.9A	24 V~	4 161 00	40 A
			24 V=	4 161 01	
			48 V~	4 161 02	
			48 V=	4 161 03	
			110 V~	4 161 04	
			230 V~	4 161 06	
			380 V~	4 161 00	
415 V~	4 161 09				
40	VH4040-3MONO	SAH2.68-44.0A	24 V~	4 161 40 / 4 161 50	80 A
			24 V=	4 161 41 / 4 161 51	
			48 V~	4 161 42 / 4 161 52	
			48 V=	4 161 43 / 4 161 53	
			110 V~	4 161 44 / 4 161 54	
			230 V~	4 161 46 / 4 161 56	
			380 V~	4 161 48 / 4 161 58	
415 V~	4 161 49 / 4 161 59				
80	VH8040-3MONO	SAH1.34-87.0A	24 V~	4 162 40 / 4 162 50	160 A
			24 V=	4 162 41 / 4 162 51	
			48 V~	4 162 42 / 4 162 52	
			48 V=	4 162 43 / 4 162 53	
			100-240 V~/=	4 162 46 / 4 162 56	
			400-440 V~	4 162 49 / 4 162 59	

Alpican capacitors



 Technical characteristics **p. 46**

Compact design in cylindrical aluminium can
 Biodegradable soft resin impregnant
 Dual safety with self healing and overpressure disconnecter
 Conforming to standard IEC 60831-1 and 2

Pack	Cat.Nos	Three-phase 400 V - 50 Hz	
Nominal power (kVAr)			
		50 Hz	60 Hz
1	4 151 60	2.5	3
1	4 151 61	5	6
1	4 151 62	6.3	7.6
1	4 151 63	7.5	9
1	4 151 64	10	12
1	4 151 65	12.5	15
1	4 151 66	15	18
1	4 151 67	20	24
1	4 151 68	25	30

Pack	Cat.Nos	Three-phase 415 V - 50 Hz	
Nominal power (kVAr)			
		50 Hz	60 Hz
1	4 151 69	2.5	3
1	4 151 70	5	6
1	4 151 71	6.3	7.6
1	4 151 72	7.5	9
1	4 151 73	10	12
1	4 151 74	12.5	15
1	4 151 75	15	18
1	4 151 76	20	24
1	4 151 77	25	30

Pack	Cat.Nos	Three-phase 440 V - 50 Hz	
Nominal power (kVAr)			
		50 Hz	60 Hz
1	4 151 78	2.5	3
1	4 151 79	5	6
1	4 151 80	6.3	7.6
1	4 151 81	7.5	9
1	4 151 82	10	12
1	4 151 83	12.5	15
1	4 151 84	15	18
1	4 151 85	20	24
1	4 151 86	25	30
1	4 151 87	30	36

Pack	Cat.Nos	Three-phase 480 V - 50 Hz	
Nominal power (kVAr)			
		50 Hz	60 Hz
1	4 151 88	5	6
1	4 151 89	10.4	12.5
1	4 151 90	12.5	15
1	4 151 91	15	18
1	4 151 92	20.8	25
1	4 151 93	25	30
1	4 151 94	30	36



Alpican capacitors

technical characteristics

Technical specifications

Discharge resistors:

Fitted inside, they discharge the unit in accordance with current standards (discharge time, 3 minutes)

Loss factor:

Alpican capacitors have a loss factor of less than 0.2×10^{-3} . This value leads to a power consumption of less than 0.45 W per kVAr, excluding the discharge resistors

Rated frequency: 50/60 Hz

Capacitance: tolerance on the capacitance value: - 5 % / 10 %

Max. permissible voltage:

1.1 Un up to 8 hours daily (according to IEC 60831-1 and 2)

Max. permissible current:

Up to 1.5 Ir including combined effects of harmonics (according to IEC 60831-1 and 2)

Inrush current: up to 200 Ir

Insulation class: 3/15 kV

Standards:

Alpican capacitors comply with:
• International standard: IEC 60831-1 and 2

Temperature class:

Alpican capacitors are designed for a standard -25D temperature class

- Maximum temperature: 55 °C
- Average over 24 hours: 45 °C
- Annual average: 35 °C
- Lowest temperature class: - 25 °C

Cooling: natural or forced

Humidity: max. 95 %

Altitude: max. 4000 m above the sea level

Mounting position: vertical

Dimensions

For capacitors from 2.5 to 5 kVAr - 400 V, 415 V and 440 V

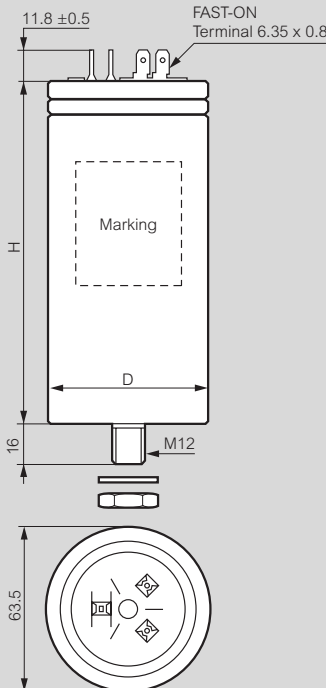

Creepage distance:
• $\varnothing 63.5$: 10.0 mm

Clearance:
• $\varnothing 63.5$: 16.5 mm

Mounting:
• $\varnothing 63.5$:
M 12, torque 10 Nm
Toothed washer J 12.5 DIN 6797
Hex nut BM 12 DIN 439

Cat.No	Nominal power at 50 Hz (kVAr)	Dimensions (mm)			Weight (kg)
		D	H	max. A	
4 151 60	2.5	63.5	129	12	0.4
4 151 61	5	63.5	129	12	0.4
4 151 69	2.5	63.5	129	13	0.4
4 151 70	5	63.5	129	12	0.4
4 151 78	2.5	63.5	129	12	0.3
4 151 79	5	63.5	154	12	0.5

Dimensions (continued)

For capacitors from 6.3 to 30 kVAr - 400 V, 415 V, 440 V and full range of 480 V capacitors

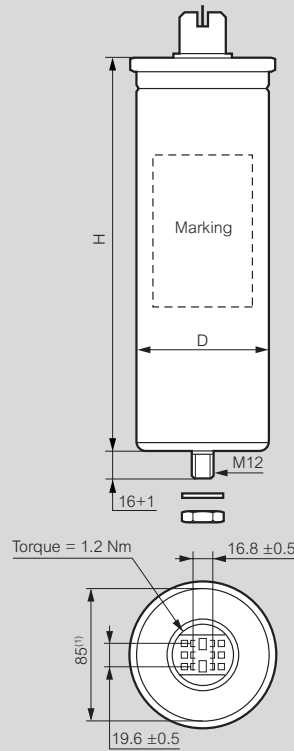

(1) Seaming adds 4 mm in diameter

Creepage distance:
• $\varnothing 75 / \varnothing 85$: 9.6 mm

Clearance:
• $\varnothing 75 / \varnothing 85$: 12.7 mm

Mounting:
• $\varnothing 75 / \varnothing 85$:
M 12, torque 10 Nm
Toothed washer J 12.5 DIN 6797
Hex nut BM 12 DIN 439

Cat.No	Nominal power at 50 Hz (kVAr)	Dimensions (mm)			Weight (kg)
		D	H	max. A	
4 151 62	6.3	75	160	13	0.5
4 151 63	7.5	75	160	13	0.5
4 151 64	10	75	198	13	0.6
4 151 65	12.5	85	198	13	0.8
4 151 66	15	85	198	13	0.8
4 151 67	20	85	273	13	1.1
4 151 68	25	85	273	13	1.5
4 151 71	6.3	75	160	13	0.5
4 151 72	7.5	75	198	13	0.6
4 151 73	10	75	198	13	0.6
4 151 74	12.5	85	198	13	0.8
4 151 75	15	85	273	13	1.2
4 151 76	20	85	273	13	1.2
4 151 77	25	85	348	13	1.5
4 151 80	6.3	75	160	13	0.5
4 151 81	7.5	75	160	13	0.5
4 151 82	10	75	198	13	0.6
4 151 83	12.5	85	198	13	0.8
4 151 84	15	85	273	13	1.2
4 151 85	20	85	273	13	1.2
4 151 86	25	85	348	13	1.5
4 151 87	30	85	348	13	1.6
4 151 88	5	75	160	13	0.5
4 151 89	10.4	85	198	13	0.8
4 151 90	12.5	85	198	13	0.8
4 151 91	15	85	273	13	1.2
4 151 92	20.8	85	273	13	1.2
4 151 93	25	85	348	13	1.5
4 151 94	30	90	348	13	1.5

Alpican capacitors

technical characteristics (continued)

■ CTX³ contactors and HRC cartridge fuses selection for capacitors without detuned reactors

Network 400 V - 50 Hz

Max. harmonic pollution THDU ≤ 2 % ; THDI ≤ 5 %

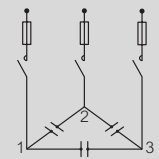
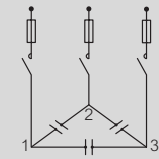
Effective power at 400 V (kVAr)	Alpican capacitors	CTX ³ contactors and switching units			HRC fuses gG	Effective power at 400 V (kVAr)	Alpican capacitors	CTX ³ contactors and switching units			HRC fuses gG
		Cat.Nos	Coil voltage	Screw terminals				Cage terminals	In	Cat.Nos	
Three-phase capacitors - capacitor voltage 400 V 						Three-phase capacitors - capacitor voltage 415 V 					
6.3	4 151 62 (6.3 kVAr at 400 V)	24 V~	4 160 80 + 4 168 74	-	16 A	6	4 151 71 (6.3 kVAr at 415 V)	24 V~	4 160 80 + 4 168 74	-	16 A
		24 V=	4 160 81 + 4 168 74	-							
		48 V~	4 160 82 + 4 168 74	-							
		48 V=	4 160 83 + 4 168 74	-							
		110 V~	4 160 84 + 4 168 74	-							
		230 V~	4 160 86 + 4 168 74	-							
		380 V~	4 160 88 + 4 168 74	-							
12.5	4 151 65 (12.5 kVAr at 400 V)	24 V~	4 160 90 + 4 168 74	-	25 A	11.5	4 151 74 (12.5 kVAr at 415 V)	24 V~	4 160 90 + 4 168 74	-	25 A
		24 V=	4 160 91 + 4 168 74	-							
		48 V~	4 160 92 + 4 168 74	-							
		48 V=	4 160 93 + 4 168 74	-							
		110 V~	4 160 94 + 4 168 74	-							
		230 V~	4 160 96 + 4 168 74	-							
		380 V~	4 160 98 + 4 168 74	-							
25	4 151 68 (25 kVAr at 400 V)	24 V~	4 161 20 + 4 168 74	-	50 A	23.2	4 151 77 (25 kVAr at 415 V)	24 V~	4 161 20 + 4 168 74	-	50 A
		24 V=	4 161 21 + 4 168 74	-							
		48 V~	4 161 22 + 4 168 74	-							
		48 V=	4 161 23 + 4 168 74	-							
		110 V~	4 161 24 + 4 168 74	-							
		230 V~	4 161 26 + 4 168 74	-							
		380 V~	4 161 28 + 4 168 74	-							
50	2 x 4 151 68 (50 kVAr at 400 V)	24 V~	4 161 80 + 4 168 77	4 161 90 + 4 168 76	100 A	46.5	2 x 4 151 77 (50 kVAr at 415 V)	24 V~	4 161 80 + 4 168 77	4 161 90 + 4 168 76	100 A
		24 V=	4 161 81 + 4 168 77	4 161 91 + 4 168 76							
		48 V~	4 161 82 + 4 168 77	4 161 92 + 4 168 76							
		48 V=	4 161 83 + 4 168 77	4 161 93 + 4 168 76							
		110 V~	4 161 84 + 4 168 77	4 161 94 + 4 168 76							
		230 V~	4 161 86 + 4 168 77	4 161 96 + 4 168 76							
		380 V~	4 161 88 + 4 168 77	4 161 98 + 4 168 76							
415 V~	4 161 89 + 4 168 77	4 161 99 + 4 168 76									



Alpican capacitors

technical characteristics (continued)

■ CTX³ contactors and HRC cartridge fuses selection for capacitors without detuned reactors (continued)

Network 400 V - 50 Hz

Max. harmonic pollution THDU ≤ 3 % ; THDI ≤ 10 %

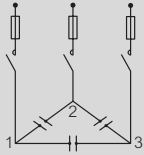
Effective power at 400 V (kVAr)	Alpican capacitors	CTX ³ contactors and switching units			HRC fuses gG
		Cat.Nos	Coil voltage	Screw terminals	
Three-phase capacitors - capacitor voltage 440 V 					
8.5	4 151 82 (10 kVAr at 440 V)	24 V~	4 160 90 + 4 168 74	-	20 A
		24 V=	4 160 91 + 4 168 74	-	
		48 V~	4 160 92 + 4 168 74	-	
		48 V=	4 160 93 + 4 168 74	-	
		110 V~	4 160 94 + 4 168 74	-	
		230 V~	4 160 96 + 4 168 74	-	
		380 V~	4 160 98 + 4 168 74	-	
		415 V~	4 160 99 + 4 168 74	-	
10	4 151 83 (12.5 kVAr at 440 V)	24 V~	4 160 90 + 4 168 74	-	25 A
		24 V=	4 160 91 + 4 168 74	-	
		48 V~	4 160 92 + 4 168 74	-	
		48 V=	4 160 93 + 4 168 74	-	
		110 V~	4 160 94 + 4 168 74	-	
		230 V~	4 160 96 + 4 168 74	-	
		380 V~	4 160 98 + 4 168 74	-	
		415 V~	4 160 99 + 4 168 74	-	
20	4 151 86 (25 kVAr at 440 V)	24 V~	4 161 20 + 4 168 74	-	50 A
		24 V=	4 161 21 + 4 168 74	-	
		48 V~	4 161 22 + 4 168 74	-	
		48 V=	4 161 23 + 4 168 74	-	
		110 V~	4 161 24 + 4 168 74	-	
		230 V~	4 161 26 + 4 168 74	-	
		380 V~	4 161 28 + 4 168 74	-	
		415 V~	4 161 29 + 4 168 74	-	
40	2 x 4 151 86 (50 kVAr at 440 V)	24 V~	4 161 80 + 4 168 77	4 161 90 + 4 168 76	80 A
		24 V=	4 161 81 + 4 168 77	4 161 91 + 4 168 76	
		48 V~	4 161 82 + 4 168 77	4 161 92 + 4 168 76	
		48 V=	4 161 82 + 4 168 77	4 161 93 + 4 168 76	
		110 V~	4 161 84 + 4 168 77	4 161 94 + 4 168 76	
		230 V~	4 161 86 + 4 168 77	4 161 96 + 4 168 76	
		380 V~	4 161 88 + 4 168 77	4 161 98 + 4 168 76	
		415 V~	4 161 89 + 4 168 77	4 161 99 + 4 168 76	
60	3 x 4 151 86 (75 kVAr at 440 V)	24 V~	4 162 20 + 4 162 77	4 162 30 + 4 168 76	125 A
		24 V=	4 162 21 + 4 162 77	4 162 31 + 4 168 76	
		48 V~	4 162 22 + 4 162 77	4 162 32 + 4 168 76	
		48 V=	4 162 23 + 4 162 77	4 162 33 + 4 168 76	
		110 V~	4 162 24 + 4 162 77	4 162 34 + 4 168 76	
		230 V~	4 162 26 + 4 162 77	4 162 36 + 4 168 76	
		380 V~	4 162 28 + 4 162 77	4 162 38 + 4 168 76	
		415 V~	4 162 29 + 4 162 77	4 162 39 + 4 168 76	

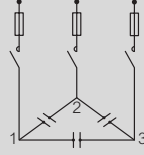
Effective power at 400 V (kVAr)	Alpican capacitors	CTX ³ contactors and switching units			HRC fuses gG
		Cat.Nos	Coil voltage	Screw terminals	
Three-phase capacitors - capacitor voltage 480 V 					
8.5	4 151 90 (12.5 kVAr at 480 V)	24 V~	4 160 90 + 4 168 74	-	20 A
		24 V=	4 160 91 + 4 168 74	-	
		48 V~	4 160 92 + 4 168 74	-	
		48 V=	4 160 93 + 4 168 74	-	
		110 V~	4 160 94 + 4 168 74	-	
		230 V~	4 160 96 + 4 168 74	-	
		380 V~	4 160 98 + 4 168 74	-	
		415 V~	4 160 99 + 4 168 74	-	
10	4 151 91 (15 kVAr at 480 V)	24 V~	4 160 90 + 4 168 74	-	25 A
		24 V=	4 160 91 + 4 168 74	-	
		48 V~	4 160 92 + 4 168 74	-	
		48 V=	4 160 93 + 4 168 74	-	
		110 V~	4 160 94 + 4 168 74	-	
		230 V~	4 160 96 + 4 168 74	-	
		380 V~	4 160 98 + 4 168 74	-	
		415 V~	4 160 99 + 4 168 74	-	
20	4 151 94 (30 kVAr at 480 V)	24 V~	4 161 20 + 4 168 74	-	50 A
		24 V=	4 161 21 + 4 168 74	-	
		48 V~	4 161 22 + 4 168 74	-	
		48 V=	4 161 23 + 4 168 74	-	
		110 V~	4 161 24 + 4 168 74	-	
		230 V~	4 161 26 + 4 168 74	-	
		380 V~	4 161 28 + 4 168 74	-	
		415 V~	4 161 29 + 4 168 74	-	
40	2 x 4 151 94 (60 kVAr at 480 V)	24 V~	4 161 80 + 4 168 77	4 161 90 + 4 168 76	80 A
		24 V=	4 161 81 + 4 168 77	4 161 91 + 4 168 76	
		48 V~	4 161 82 + 4 168 77	4 161 92 + 4 168 76	
		48 V=	4 161 82 + 4 168 77	4 161 93 + 4 168 76	
		110 V~	4 161 84 + 4 168 77	4 161 94 + 4 168 76	
		230 V~	4 161 86 + 4 168 77	4 161 96 + 4 168 76	
		380 V~	4 161 88 + 4 168 77	4 161 98 + 4 168 76	
		415 V~	4 161 89 + 4 168 77	4 161 99 + 4 168 76	
60	3 x 4 151 94 (90 kVAr at 480 V)	24 V~	4 162 20 + 4 162 77	4 162 30 + 4 168 76	125 A
		24 V=	4 162 21 + 4 162 77	4 162 31 + 4 168 76	
		48 V~	4 162 22 + 4 162 77	4 162 32 + 4 168 76	
		48 V=	4 162 23 + 4 162 77	4 162 33 + 4 168 76	
		110 V~	4 162 24 + 4 162 77	4 162 34 + 4 168 76	
		230 V~	4 162 26 + 4 162 77	4 162 36 + 4 168 76	
		380 V~	4 162 28 + 4 162 77	4 162 38 + 4 168 76	
		415 V~	4 162 29 + 4 162 77	4 162 39 + 4 168 76	

Alpican capacitors

technical characteristics (continued)

■ CTX³ contactors and HRC cartridge fuses selection for capacitors with detuned reactors

Network 400 V - 50 Hz

Max. harmonic pollution THDU ≤ 6 % ; THDI ≤ 30 %

Effective power at 400 V (kVAr)	Alpican capacitors Cat.Nos	Detuned reactor 189 Hz (p = 7%) Cat.Nos	CTX ³ contactors and switching units		HRC fuses gG In
			Coil voltage	Screw terminals / Cage terminals	
Three-phase capacitors 440 V, 7 % detuned reactor					
8.5	4 151 82 (10 kVAr at 440 V)	SAH4.31-16.2A	24 V~	4 161 00	20 A
			24 V=	4 161 01	
			48 V~	4 161 02	
			48 V=	4 161 03	
			110 V~	4 161 04	
			230 V~	4 161 06	
			380 V~	4 161 08	
415 V~	4 161 09				
10	4 151 83 (12.5 kVAr at 440 V)	SAH3.45-20.2A	24 V~	4 161 00	25 A
			24 V=	4 161 01	
			48 V~	4 161 02	
			48 V=	4 161 03	
			110 V~	4 161 04	
			230 V~	4 161 06	
			380 V~	4 161 08	
415 V~	4 161 09				
20	4 151 86 (25 kVAr at 440 V)	SAH1.73-40.4A	24 V~	4 161 30	50 A
			24 V=	4 161 31	
			48 V~	4 161 32	
			48 V=	4 161 33	
			110 V~	4 161 34	
			230 V~	4 161 36	
			380 V~	4 161 38	
415 V~	4 161 39				
40	2 x 4 151 86 (50 kVAr at 440 V)	SAH0.86-80.8A	24 V~	4 161 60 / 4 161 70	80 A
			24 V=	4 161 61 / 4 161 71	
			48 V~	4 161 62 / 4 161 72	
			48 V=	4 161 63 / 4 161 73	
			110 V~	4 161 66 / 4 161 74	
			230 V~	4 161 66 / 4 161 76	
			380 V~	4 161 68 / 4 161 78	
415 V~	4 161 69 / 4 161 79				
60	3 x 4 151 86 (75 kVAr at 440 V)	SAH0.58-121.2A	24 V~	4 162 20 / 4 162 30	125 A
			24 V=	4 162 21 / 4 162 31	
			48 V~	4 162 22 / 4 162 32	
			48 V=	4 162 23 / 4 162 33	
			110 V~	4 162 24 / 4 162 34	
			230 V~	4 162 26 / 4 162 36	
			380 V~	4 162 28 / 4 162 38	
415 V~	4 162 29 / 4 162 39				
80	4 x 4 151 86 (100 kVAr at 440 V)	SAH0.43-161.6A	24 V~	4 162 60 / 4 162 70	160 A
			24 V=	4 162 61 / 4 162 71	
			48 V~	4 162 62 / 4 162 72	
			48 V=	4 162 63 / 4 162 73	
			100-240 V~ / =	4 162 66 / 4 162 76	
400-440 V~	4 162 68 / 4 162 79				
Three-phase capacitors 480 V, 7 % detuned reactor					
8.5	4 151 90 (12.5 kVAr at 480 V)	SAH4.31-16.2A	24 V~	4 161 00	20 A
			24 V=	4 161 01	
			48 V~	4 161 02	
			48 V=	4 161 03	
			110 V~	4 161 04	
			230 V~	4 161 06	
			380 V~	4 161 08	
415 V~	4 161 09				
10	4 151 91 (15 kVAr at 480 V)	SAH3.45-20.2A	24 V~	4 161 00	25 A
			24 V=	4 161 01	
			48 V~	4 161 02	
			48 V=	4 161 03	
			110 V~	4 161 04	
			230 V~	4 161 06	
			380 V~	4 161 08	
415 V~	4 161 09				
20	4 151 94 (30 kVAr at 480 V)	SAH1.73-40.4A	24 V~	4 161 30	50 A
			24 V=	4 161 31	
			48 V~	4 161 32	
			48 V=	4 161 33	
			110 V~	4 161 34	
			230 V~	4 161 36	
			380 V~	4 161 38	
415 V~	4 161 39				
40	2 x 4 151 94 (60 kVAr at 480 V)	SAH0.86-80.8A	24 V~	4 161 60 / 4 161 70	80 A
			24 V=	4 161 61 / 4 161 71	
			48 V~	4 161 62 / 4 161 72	
			48 V=	4 161 63 / 4 161 73	
			110 V~	4 161 66 / 4 161 74	
			230 V~	4 161 66 / 4 161 76	
			380 V~	4 161 68 / 4 161 78	
415 V~	4 161 69 / 4 161 79				
60	3 x 4 151 94 (90 kVAr at 480 V)	SAH0.58-121.2A	24 V~	4 162 20 / 4 162 30	125 A
			24 V=	4 162 21 / 4 162 31	
			48 V~	4 162 22 / 4 162 32	
			48 V=	4 162 23 / 4 162 33	
			110 V~	4 162 24 / 4 162 34	
			230 V~	4 162 26 / 4 162 36	
			380 V~	4 162 28 / 4 162 38	
415 V~	4 162 29 / 4 162 39				
80	4 x 4 151 94 (120 kVAr at 480 V)	SAH0.43-161.6A	24 V~	4 162 60 / 4 162 70	160 A
			24 V=	4 162 61 / 4 162 71	
			48 V~	4 162 62 / 4 162 72	
			48 V=	4 162 63 / 4 162 73	
			100-240 V~ / =	4 162 66 / 4 162 76	
400-440 V~	4 162 68 / 4 162 79				



Alpican capacitors

technical characteristics (continued)

■ CTX³ contactors and HRC cartridge fuses selection for capacitors with detuned reactors (continued)

Network 400 V - 50 Hz

Max. harmonic pollution THDU ≤ 6 % ; THDI ≤ 30 %

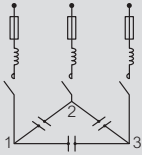
Effective power at 400 V (kVAr)	Alpican capacitors	Detuned reactor 135 Hz (p = 14%)	CTX ³ contactors and switching units		HRC fuses gG
	Cat.Nos	Cat.Nos	Coil voltage	Screw terminals / Cage terminals	In
	Three-phase capacitors 440 V, 14 % detuned reactor 				
10	4 151 90 (12.5 kVAr at 480 V)	SAH8.10-15.7A	24 V~	4 161 00	25 A
			24 V=	4 161 01	
			48 V~	4 161 02	
			48 V=	4 161 03	
			110 V~	4 161 04	
			230 V~	4 161 06	
			380 V~	4 161 08	
20	4 151 93 (25 kVAr at 480 V)	SAH4.05-31.4A	415 V~	4 161 09	50 A
			24 V~	4 161 30	
			24 V=	4 161 31	
			48 V~	4 161 32	
			48 V=	4 161 33	
			110 V~	4 161 34	
			230 V~	4 161 36	
40	2 x 4 151 93 (50 kVAr at 480 V)	SAH2.02-62.8A	380 V~	4 161 38	80 A
			415 V~	4 161 39	
			24 V~	4 161 60 / 4 161 70	
			24 V=	4 161 61 / 4 161 71	
			48 V~	4 161 62 / 4 161 72	
			48 V=	4 161 63 / 4 161 73	
			110 V~	4 161 66 / 4 161 74	
60	3 x 4 151 93 (75 kVAr at 480 V)	SAH1.35-94.2A	230 V~	4 161 66 / 4 161 76	125 A
			380 V~	4 161 68 / 4 161 78	
			415 V~	4 161 69 / 4 161 79	
			24 V~	4 162 20 / 4 162 30	
			24 V=	4 162 21 / 4 162 31	
			48 V~	4 162 22 / 4 162 32	
			48 V=	4 162 23 / 4 162 33	
80	4 x 4 151 93 (100 kVAr at 480 V)	SAH0.43-161.6A	110 V~	4 162 24 / 4 162 34	160 A
			230 V~	4 162 26 / 4 162 36	
			380 V~	4 162 28 / 4 162 38	
			415 V~	4 162 29 / 4 162 39	
			24 V~	4 162 60 / 4 162 70	
			24 V=	4 162 61 / 4 162 71	
			48 V~	4 162 62 / 4 162 72	
48 V=	4 162 63 / 4 162 73				
			100-240 V~ / =	4 162 66 / 4 162 76	
			400-440 V~	4 162 68 / 4 162 79	

Contactors CTX³

technical characteristics

Environmental conditions

- Storage temperature: -50 °C to +40 °C
- Operating temperature: -5 °C to +40 °C
- Operating altitude: 3000 m
- Protection degree: IP 20
- Shock resistance: open 8 G / closed 10 G
- Vibration resistance (5-300 Hz): open 2 G / closed 4 G

CTX³ capacitor switching units Cat.Nos 4 168 74/75/76/77

Capacitor unit is connected to the terminals of the contactor to reduce the high inrush current.
IEC 60947-4-1 AC 6b

Type	Contactor		Maximum operating power (kvar)			Max. Peak current (A)
			220 - 240 V	400 - 440 V	500 - 550 V	
4 168 74	CTX ³ 22	9 A	5	9.7	14	560
	CTX ³ 22	12 A	6.7	12.5	18	560
	CTX ³ 22	18 A	8.5	16.7	24	850
	CTX ³ 22	22 A	10	18	26	1250
	CTX ³ 40	32 A	15	25	36	1900
	CTX ³ 40	40 A	20	33.3	48	2160
4 168 75/76	CTX ³ 65	50 A	20	40	58	2160
	CTX ³ 65	65 A	25	45.7	66	3040
4 168 76/77	CTX ³ 100	75 A	29.7	54	78	3040
	CTX ³ 100	85 A	35	60	92	3040
	CTX ³ 100	100 A	37	62	94	3040

Note: - When the switch is closed capacitor must be discharged before recharged. (Maximum residual voltage at terminals ≤ 50 V)
- To prevent short current, gG type fuse must be 1.5 - 2 times than rated current

Features of capacitor unit (Pre-loading resistor)

- Damping resistor that can limit the inrush current up to 60 x I_n by closing earlier than the main contacts of the contactor
- No heat loss by the serial resistor
- Eliminates the switching surge
- Improves the performance of the capacitor system

Operation sequence

Capacitor unit: OFF
Contactor: OFF

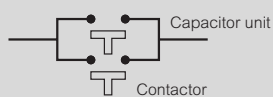

Fig.1

Capacitor unit: ON
Contactor: OFF

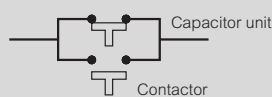

Fig.2

Capacitor unit: OFF
Contactor: ON

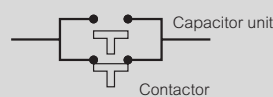

Fig.3

Note - Closing sequence: Fig.1 => Fig.2 => Fig.3
Opening sequence: Fig.3 => Fig.1



Contactors CTX³

technical characteristics (continued)

■ CTX³ capacitor switching units Cat.Nos 4 168 74/75/76/77 (continued)

Overall dimensions of contactors equipped with CTX³ switching units

Cat.No 4 168 74 on CTX³ 22

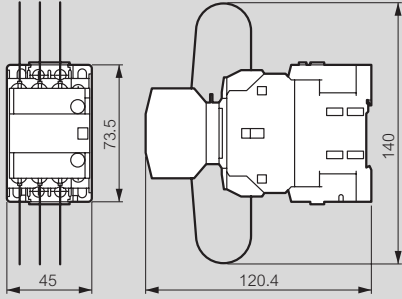

Cat.No 4 168 75/76 on CTX³ 65

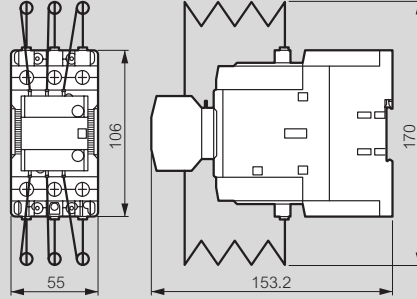

Cat.No 4 168 74 on CTX³ 40

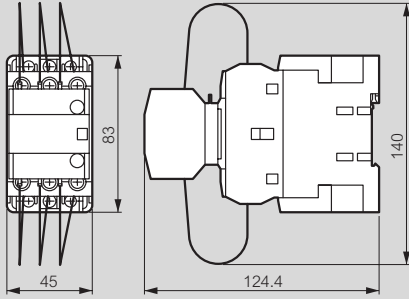

Cat.No 4 168 76/77 on CTX³ 100

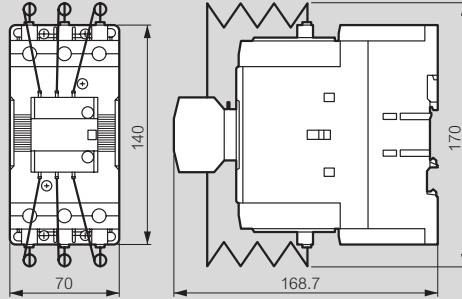

Detuned reactors



SAH1.73-40.4A

SAH5.36-23.9A

The Alptec detuned reactors are designed to protect the capacitors against harmonics and avoid parallel resonance and amplification of harmonics flowing on the network

The connection of these reactors in series with capacitors causes a shift of the resonance frequency of the circuit composed by feeding transformer-reactors- capacitors so that the resulting self-resonance frequency is well below the line harmonics

The blocking factor $p\%$ is expressed by the ratio between inductive reactance and capacitive reactance it corresponds to the increase of voltage applied to capacitors, with respect to line voltage, due to circulation of capacitive current in the reactor
Conforming to standards IEC 60076-6

Detuned reactors three-phase 50 Hz tuning frequency 189 Hz

$P\% = 7 / n = 3.78$
Max. harmonic pollution THDu $\leq 6\%$,
THDi $\leq 30\%$
To be associated with 440 V / 480 V capacitors

For three-phase capacitors

Pack	Cat.Nos	L_n (mH)	I RMS (A)
1	SAH4.31-16.2A	4.31	16.2
1	SAH3.45-20.2A	3.45	20.2
1	SAH2.85-21.0A	2.85	21
1	SAH1.78-38.0A	1.78	38
1	SAH1.73-40.4A	1.73	40.4
1	SAH1.45-42.0A	1.45	42
1	SAH0.90-75.0A	0.90	75
1	SAH0.86-80.8A	0.86	80.8
1	SAH0.72-83.0A	0.72	83
1	SAH0.58-121.2A	0.58	121.2
1	SAH0.48-123.0A	0.48	123
1	SAH0.45-150.0A	0.45	150
1	SAH0.43-161.6A	0.43	161.6

For 3 single-phase capacitors

Pack	Cat.Nos	L_n (mH)	I RMS (A)
1	SAH10.70-12.0A	10.70	12
1	SAH8.55-12.6A	8.55	12.6
1	SAH5.36-23.9A	5.36	23.9
1	SAH4.30-25.1A	4.30	25.1
1	SAH2.68-44.0A	2.68	44
1	SAH2.15-50.0A	2.15	50
1	SAH1.44-74.4A	1.44	74.4
1	SAH1.34-87.0A	1.34	87

Detuned reactors three-phase 50 Hz tuning frequency 135 Hz

$P\% = 14 / n = 2.7$
Max. harmonic pollution THDu $\leq 6\%$,
THDi $\leq 30\%$
To be associated with 480 V capacitors

For three-phase capacitors

Pack	Cat.Nos	L_n (mH)	I RMS (A)
1	SAH8.10-15.7A	8.1	15.7
1	SAH4.05-31.4A	4.05	28.9
1	SAH2.02-62.8A	2.02	62.8
1	SAH1.35-94.2A	1.35	94.2
1	SAH1.00-125.6A	1	125.6

For 3 single-phase capacitors

Pack	Cat.Nos	L_n (mH)	I RMS (A)
1	SAH14.10-16.0A	14.1	16
1	SAH7.05-31.0A	7.05	31
1	SAH3.52-62.0A	3.52	62

Detuned reactors

Technical specifications

- Rated line voltage: 400 V / 440 V
- Rated frequency: 50 Hz
- Tolerance on inductance: 0 / + 6 %
- Dielectric test 50 Hz, 3 kV, 60 s, protection class: IP 00
- Cooling method: natural air (AN)
- Ambient temperature: - 5 to + 40 °C
- Elevation above sea level: 1000 m a.s.l
- Insulation class H
- Insulation level 1.1 kV
- Blocking factor $p\% = 7$ - Tuning order = $3.78 / p\% = 13.7$ - Tuning order = 2.7
- Thermal protection switch (250 V, 2.5 A) wired on terminal block

Installation and requirements

- Operation and storage temperature: - 25 to + 70 °C
- Selection of the right type according to harmonic pollution
- In operation an adequate air circulation must be guaranteed
- Windings must be installed vertically for better heat dissipation
- The reactor must be protected against overloads and short-circuits by fuses and/or circuit breakers
- Suitable protection against undesired contacts (IP00) must be provided by means of enclosures or boxes protecting the power system where the reactor is installed
- It is imperative that the thermal N.C dry contact be connected in series with the contactor coil, in order to disconnect the step in case of overheating

Dimensions

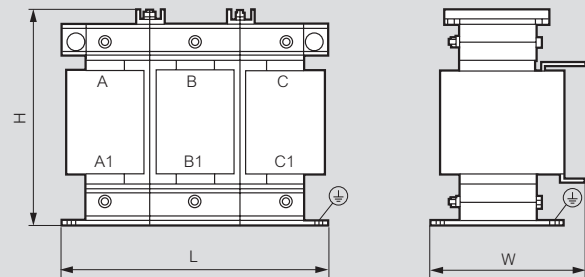

Aluminium bars

Cat.Nos	L_n (mH)	I RMS (A)	Ptot (W)	Dimensions (mm)			Weight (kg)
				L	W	H	
Tuning frequency 189 Hz							
SAH4.31-16.2A	4.31	16.2	85	180	140	190	11
SAH3.45-20.2A	3.45	20.2	105	180	140	190	11
SAH2.85-21.0A	2.85	21	100	180	115	180	8.5
SAH1.78-38.0A	1.78	38	165	240	140	215	16
SAH1.73-40.4A	1.73	40.4	210	240	140	255	17
SAH1.45-42.0A	1.45	42	160	240	120	225	12
SAH0.90-75.0A	0.9	75	280	240	165	260	26.5
SAH0.86-80.8A	0.86	80.8	270	240	165	280	28
SAH0.72-83.0A	0.72	83	230	240	160	225	22
SAH0.58-121.2A	0.58	121.2	400	300	190	315	40
SAH0.48-123.0A	0.48	123	400	240	172	260	28.5
SAH0.45-150.0A	0.45	150	480	310	200	310	40
SAH0.43-161.6A	0.43	161.6	425	320	210	315	50
SAH10.70-12.0A	10.7	12	170	180	160	185	15
SAH8.55-12.6A	8.55	12.6	100	180	120	190	9.5
SAH5.36-23.9A	5.36	23.9	160	240	185	215	26.5
SAH4.30-25.1A	4.3	25.1	130	240	130	235	13.5
SAH2.68-44.0A	2.68	44	215	240	175	205	25.5
SAH2.15-50.0A	2.15	50	195	240	160	245	23
SAH1.44-74.4A	1.44	74.4	305	240	167	265	29
SAH1.34-87.0A	1.34	87	550	205	200	280	35
Tuning frequency 135 Hz							
SAH8.10-15.7A	8.1	15.7	130	240	140	220	14.5
SAH4.05-31.4A	4.05	28.9	225	240	160	240	22
SAH2.02-62.8A	2.02	62.8	395	300	180	315	38
SAH1.35-94.2A	1.35	94.2	475	320	210	325	51
SAH1.00-125.6A	1	125.6	615	360	210	375	65
SAH14.10-16.0A	14.1	16	170	240	140	205	18
SAH7.05-31.0A	7.05	31	240	240	160	240	27.5
SAH3.52-62.0A	3.52	62	475	340	213	300	53

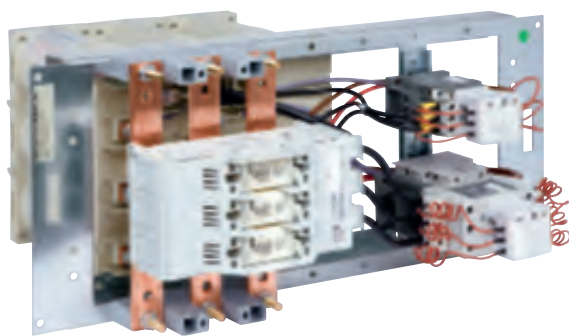

P255040

Technical characteristics opposite

400 V - 50 Hz three-phase network
 Factory connected units for integration in universal or distribution enclosures for automatic compensation systems
 S and H type:

- 1 Alpivar³ capacitor
- 1 or 2 CTX³ contactors with damping resistor suitable for capacitive currents for step control
- 1 set of 3 HRC fuses
- 1 set of modular copper busbars with junction bars for connecting several racks
- 1 steel frame on which the components are assembled and wired

Pack	Cat.Nos	S type	
		Max. harmonic pollution level THDU ≤ 3%, THDI ≤ 10%	
		Nominal power (kVAr)	For enclosures width (mm)
1	P12.540	12.5	600
1	P12.512.540	12.5 (+12.5)	600
1	P2540	25	600
1	P252540	25 (+25)	600
1	P5040	50	600
1	P255040	25 (+50)	600
1	P7540	75	600
		H type	
		Max. harmonic pollution level THDU ≤ 4%, THDI ≤ 15%	
		Nominal power (kVAr)	For enclosures width (mm)
1	PH12.540	12.5	600
1	PH12.512.540	12.5 (+12.5)	600
1	PH2540	25	600
1	PH252540	25 (+25)	600
1	PH5040	50	600
1	PH255040	25 (+50)	600
1	PH7540	75	600

Technical specifications

Loss factor

S and H type Alpimatic racks have a loss factor of 2 W/kVar

Standards

Racks for integration in automatic compensation systems complying with standard IEC 61921

Temperature class

- operation: -10 to +45°C (average over 24 hours: 40°C)
- storage : -30 to +60°C

Dimensions

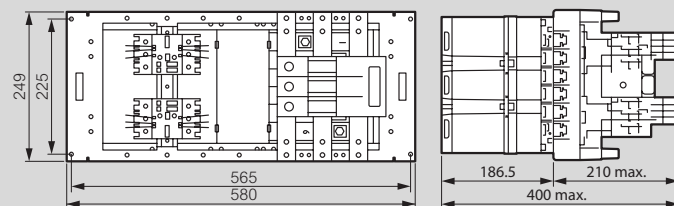

S type

	Weight (kg)
P12.540	14
P12.512.540	17
P2540	14
P252540	17
P5040	17
P255040	20
P7540	20

H type

	Weight (kg)
PH12.540	14
PH12.512.540	17
PH2540	14
PH252540	17
PH5040	17
PH255040	20
PH7540	20

Selection guide to maintenance capacitors and contactors for Alpimatic racks

Alpimatic racks S type	Alpimatic racks H type	kVAr	Maintenance capacitor Cat.No	Maintenance contactor Cat.No
P12.540	PH12.540	12.5	VH12.540-3MONO	(4 161 19 + 4 168 74) x 1
P12.512.540	PH12.512.540	12.5 +12.5	VH12.5+12.540-3MONO	(4 161 19 + 4 168 74) x 2
P2540	PH2540	25	VH2540-3MONO	(4 161 19 + 4 168 74) x 1
P252540	PH252540	25 +25	VH25+2.540-3MONO	(4 161 19 + 4 168 74) x 2
P5040	PH5040	50	VH5040-3MONO	(4 161 59 + 4 168 76) x 1
P255040	PH255040	25(+50)	VH25+5.040-3MONO	(4 161 19 + 4 168 74) x 1 + (4 162 59 + 4 168 76) x 1
P7540	PH7540	75	VH7540-3MONO	(4 161 39 + 4 168 76) x 1

CTX³ contactors for maintenance of Alpimatic racks **p. 35**



Alpimatic racks with detuned reactor

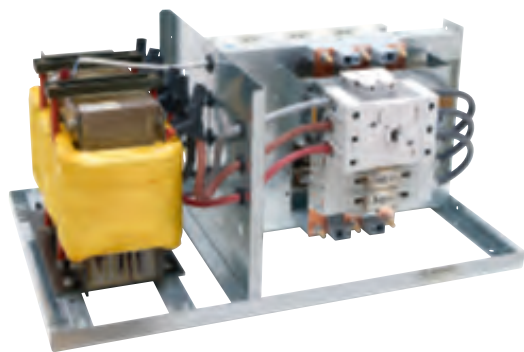

R7.R8040.189

Technical characteristics **opposite**

- 400 V - 50 Hz three-phase network
 Factory connected units for integration in universal or distribution enclosures for automatic compensation systems
 SAH versions (with detuned reactor):
- 1 Alpivar³ capacitor
 - 1 CTX3 electromechanical contactor for step control
 - 1 detuned reactor with thermal protection
 - 1 set of 3 HRC fuses
 - 1 set of modular copper busbars with junction bars for connecting several racks
 - 1 steel frame on which the components are assembled and wired

Pack	Cat.Nos	SAH type
		Max. harmonic pollution level THDU ≤ 6%, THDI ≤ 30%
		189 Hz (p = 7%)
		Nominal power (kVAr) For enclosures width (mm)
1	R5.12.540.189	12.5 600
1	R5.2540.189	25 600
1	R5.5040.189	50 600
1	R7.12.540.189	12.5 800
1	R7.2540.189	25 800
1	R7.5040.189	50 800
1	R7.7540.189	75 800

Pack	Cat.Nos	SAH reinforced type
		Max. harmonic pollution level THDU ≤ 8%, THDI ≤ 40%
		189 Hz (p = 7%)
		Nominal power (kVAr) For enclosures width (mm)
1	R5.R2040.189	20 600
1	R5.R4040.189	40 600
1	R7.R2040.189	20 800
1	R7.R4040.189	40 800
1	R7.R8040.189	80 800

Pack	Cat.Nos	SAH extra-reinforced type
		Max. harmonic pollution level THDU ≤ 11%, THDI ≤ 55%
		215 Hz (p = 5.41 %)
		At this harmonic level, we strongly recommend that you contact us to take on-site measurements
		Nominal power (kVAr) For enclosures width (mm)
1	R9.RS7240.215	72 1000

Alpimatic racks with detuned reactor

Technical specifications

Loss factor

Alpimatic racks with detuned reactor have a loss factor of 6W/kVar

Standards

Racks for integration in automatic compensation systems complying with standard IEC 61921

Dimensions

Racks for 600 mm wide enclosures

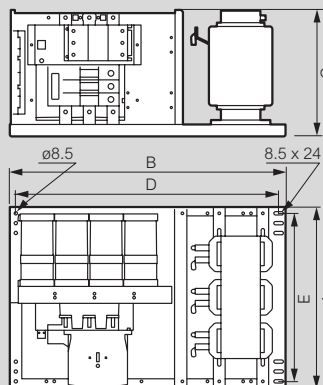

Racks for 800 and 1000 mm wide enclosures

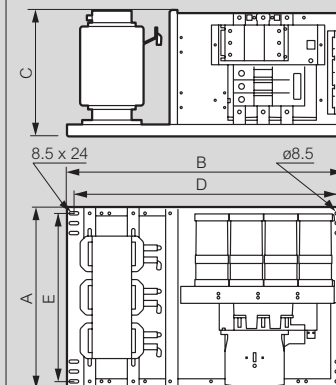

SAH type	Dimensions (mm)					
	A	B	C	D	E	Weight (kg)
R5.12.540.189	458	500	325	468	425	34
R5.2540.189	458	500	325	468	425	34
R5.5040.189	458	500	325	468	425	40
R7.12.540.189	458	700	325	665	425	35
R7.2540.189	458	700	325	665	425	35
R7.5040.189	458	700	325	665	425	41
R7.7540.189	458	700	325	665	425	50

SAH reinforced type	Dimensions (mm)					
	A	B	C	D	E	Weight (kg)
R5.R2040.189	458	500	325	468	425	45
R5.R4040.189	458	500	325	468	425	47
R7.R2040.189	458	700	325	665	425	46
R7.R4040.189	458	700	325	665	425	48
R7.R8040.189	458	700	325	665	425	78

SAH extra-reinforced type	Dimensions (mm)					
	A	B	C	D	E	Weight (kg)
R9.RS7240.215	558	900	400	865	425	90

Selection guide to maintenance capacitors and contactors for Alpimatic racks with detuned reactor

Alpimatic racks for enclosure width 600 mm	Alpimatic racks for enclosure width 800 mm	kVAr	Maintenance capacitor Cat.No	Maintenance contactor Cat.No
SAH type				
R5.12.540.189	R7.12.540.189	12.5	VH12.540-3MONO	4 161 19
R5.2540.189	R7.2540.189	25	VH2540-3MONO	4 161 19
R5.5040.189	R7.5040.189	50	VH5040-3MONO	4 161 39
*	R7.7540.189	75	VH7540-3MONO-1	4 161 79
SAH reinforced type				
R5.R2040.189	R7.R2040.189	20	VH2040-3MONO	4 161 19
R5.R4040.189	R7.R4040.189	40	VH4040-3MONO	4 161 39
*	R7.R8040.189	80	VH8040-3MONO-1	4 162 59

Alpimatic racks for enclosure width 1000 mm	kVAr	Maintenance capacitor references	Maintenance contactor references
SAH extra-reinforced type			
R9.RS7240.215	72	VRS7240-3MONO	4 162 59



Alpistatic racks with detuned reactor

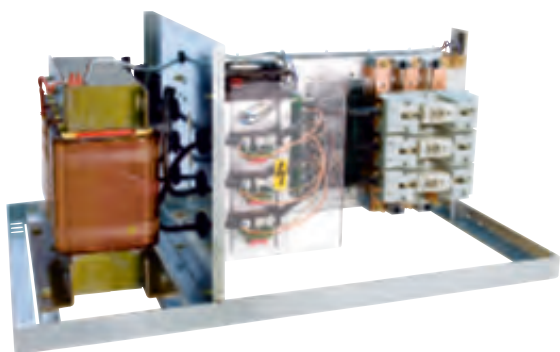

RST7.2540.189

Technical characteristics **opposite**

400 V - 50 Hz three-phase network
 Factory connected units for integration in universal or distribution enclosures for automatic compensation systems
 Comprise:
 - 1 Alpivar³ capacitor
 - 1 thyristor-controlled solid state contactor for step control
 - 1 detuned reactor
 - 1 set of 3 HRC fuses
 - 1 set of modular copper busbars with junction bars for connecting several racks
 - 1 steel frame on which the components are assembled and wired

Pack	Cat.Nos	SAH type	
		Max. harmonic pollution level THDU ≤ 6%, THDI ≤ 30%	
		189 Hz (p = 7%)	For enclosures width (mm)
		Nominal power (kVAr)	
1	RST7.2540.189	25	800
1	RST7.5040.189	50	800
1	RST7.7540.189	75	800
1	RST9.10040.189	100	1000
1	RST9.12540.189	125	1000

Pack	Cat.Nos	SAH reinforced type	
		Max. harmonic pollution level THDU ≤ 8%, THDI ≤ 40%	
		189 Hz (p = 7%)	For enclosures width (mm)
		Nominal power (kVAr)	
1	RST7.R4040.189	40	800
1	RST7.R8040.189	80	800
1	RST9.R12040.189	120	1000

Pack	Cat.Nos	SAH extra-reinforced type	
		Max. harmonic pollution level THDU ≤ 11%, THDI ≤ 55%	
		215 Hz (p = 5.41%)	For enclosures width (mm)
		At this harmonic level, we strongly recommend that you contact us to take on-site measurements	
		Nominal power (kVAr)	
1	RST9.RS7240.215	72	1000

Alpistatic racks with detuned reactor

Technical specifications

Standards

Racks for integration in dynamic compensation systems complying with standard IEC 61921

Dimensions

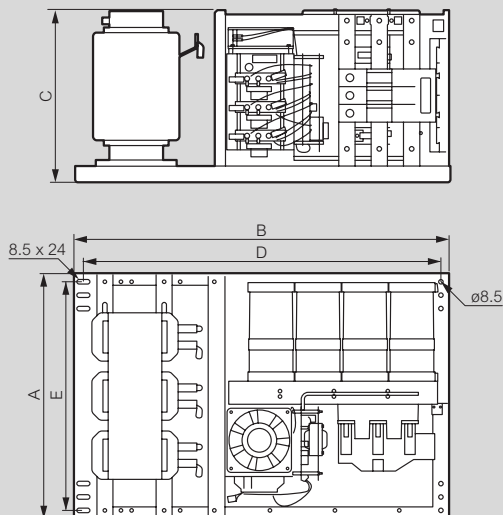

SAH type	Dimensions (mm)					Weight (kg)
	A	B	C	D	E	
RST7.2540.189	458	700	325	665	425	49
RST7.5040.189	458	700	325	665	425	57
RST7.7540.189	458	700	325	665	425	62
RST9.10040.189	458	700	325	665	425	80
RST9.12540.189	458	700	325	665	425	90

SAH reinforced type	Dimensions (mm)					Weight (kg)
	A	B	C	D	E	
RST7.R4040.189	458	700	325	665	425	62
RST7.R8040.189	458	700	325	665	425	82
RST9.R12040.189	458	700	325	665	425	90

SAH extra-reinforced type	Dimensions (mm)					Weight (kg)
	A	B	C	D	E	
RST9.RS7240.215	558	900	400	865	425	95

Selection guide to maintenance capacitors and contactors for Alpistatic racks

Alpistatic RACK - SAH type	kVAr	Maintenance capacitor Cat.No
RST7.2540.189	25	VH2540-3MONO
RST7.5040.189	50	VH5040-3MONO
RST7.7540.189	75	VH7540-3MONO-1
RST9.10040.189	100	VH10040-3MONO
RST9.12540.189	125	VH12540-3MONO

Alpistatic RACK - SAH reinforced type	kVAr	Maintenance capacitor Cat.No
RST7.R4040.189	40	VH4040-3MONO
RST7.R8040.189	80	VH8040-3MONO-1
RST9.R12040.189	120	VH12040-3MONO

Alpistatic RACK - SAH extra-reinforced type	kVAr	Maintenance capacitor Cat.No
RST9.RS7240.215	72	VRS7240-3MONO

Alptec 3.2/5.2/8.2 and Alptec 8 automatic power factor controllers



ALPTEC3.2



ALPTEC5.2



ALPTEC8



Technical characteristics p. 59-62

Pack	Cat.Nos	Alptec 3.2/5.2/8.2 automatic power factor controllers	Pack	Cat.Nos	Alptec 8 power factor controller
		<p>Control connection and disconnection of steps in order to maintain the target power factor. Detect critical operating conditions (also in systems with significant presence of harmonics) and protect the power factor correction system. Connection on single and three-phase lines, three-phase lines with neutral control and cogeneration systems with operation in 4 quadrants. For use with medium voltage applications.</p> <ul style="list-style-type: none"> • Main functions: <ul style="list-style-type: none"> - setting the power factor setting range - automatic identification of the Ti current direction - fewer switching operations - balancing of steps with similar nominal power - reactive power measurement for each installed step - recording of number of connections per step - capacitor protection against overcurrents and overloads - temperature rise protection via the internal sensor - undervoltage protection - analysis of harmonics and protection according to the level of THDU THDI - fast CT programming function • Equipped with: <ul style="list-style-type: none"> - optical USB port on the front for controller programming, diagnostics and downloading data - backlit LCD screen for easy data reading, including when the lighting conditions are poor (6 languages available) - USB and Wi-Fi communication interface for connection to a computer, smartphone or tablet <p>Can be equipped with special extension modules to extend their functionality Conform to standards IEC 61010-1, IEC/EN 61000-6-2, IEC/EN 61000-6-3, UL508, CSA C22.2 no. 14</p>	1	ALPTEC8	<p>8 steps with possible extension to 18 steps maximum. Takes up to 4 extension modules. Controls connection and disconnection of steps in order to maintain the target power factor. Detects critical operating conditions (also in systems with significant presence of harmonics) and protects the power factor correction system. Connection on single and three-phase lines, three-phase lines with neutral control and cogeneration systems with operation in 4 quadrants. For use with medium voltage applications.</p> <ul style="list-style-type: none"> • Main functions: <ul style="list-style-type: none"> - setting the power factor or phi tangent setting range - automatic identification of the Ti current direction - fewer switching operations - balancing of steps with similar nominal power - reactive power measurement for each installed step - recording the number of connections per step - capacitor protection against overcurrents and overloads on all three phases - temperature rise protection via the internal sensor - undervoltage protection - analysis of current and voltage harmonics - analysis of current and voltage waveforms recorded for overload events - CT fast programming function • Equipped with: <ul style="list-style-type: none"> - optical USB port on the front for controller programming, diagnostics and downloading data - backlit LCD screen for easy data reading, including when the lighting conditions are poor (10 languages available) - USB and Wi-Fi communication interface for connection to a computer, smartphone or tablet <p>Can be equipped with special extension modules to extend its functionality Conforms to standards IEC 61010-1, IEC/EN 61000-6-2, IEC/EN 61000-6-3, UL508, CSA C22.2 no. 14</p>
1	ALPTEC3.2	3 steps with possible extension to 6 steps; Takes 1 extension module			
1	ALPTEC5.2	5 steps with possible extension to 8 steps; Takes 1 extension module			
1	ALPTEC8.2	8 steps with possible extension to 14 steps; Takes 2 extension modules			



Accessories for Alptec automatic power factor controllers



EXT2GR

Technical characteristics p. 59-62

Pack	Cat.Nos	Extension modules
		Fit behind the power factor controller
1	EXT2GR	Output extension module for Alptec 8 and Alptec 3.2/5.2/8.2 2 relay outputs Can be used to increase the number of steps
1	EXT3GR	3 relay outputs Can be used to increase the number of steps
1	EXT4GRS	Output extension module for Alptec 8 4 solid state outputs - optically isolated. For applications using solid state contactors
1	EXTHARM	Protection against harmonics
1	EXTRS485	Communication module for Alptec 8 and Alptec 3.2/5.2/8.2 Optically isolated RS 485 communication interface
1	EXTETH	Communication module for Alptec 8 Optically isolated Ethernet communication interface
1	EXTPROFI	Optically isolated Profibus DP interface
		Communication accessories
		These communication devices can be used to connect Alptec power factor controllers to a computer, smartphone or tablet
1	4 226 87 ¹	USB connection device Computer connection cable with USB connector For Alptec 8 and Alptec 3.2/5.2/8.2 For programming, downloading data, diagnostics and upgrading the firmware The computer identifies the connection as a standard USB connection. There is no need to switch off the controller power supply
1	4 226 88 ¹	Wi-Fi connection device Wi-Fi connection device compatible with computers, smartphones and tablets For Alptec 8 and Alptec 3.2/5.2/8.2 For programming, downloading data, diagnostics and upgrading the firmware

¹: Configuration software available for downloading from the website alpestechnologies.com

Current transformers (CT)



4 121 62

Technical characteristics p. 62

Pack	Cat.Nos	Split core current transformers
		Can be combined with ammeters, electricity meters, measurement control units or power factor controllers (for calculating the $\cos \phi$ as well as the voltage reference) 5 A secondary current For fixing on a bar When used with power factor controllers, current transformers must be positioned on a different phase to the one for the voltage (L1 as standard) upstream of all the loads to be compensated Secondary connection by terminals, or by a lug Precision 0.5%
		For 50 x 80 mm bar
		Transformation ratio Power (VA)
1	4 121 62	400/5 1.5
1	4 121 63	800/5 3
		For 80 x 120 mm bar
1	4 121 64	1000/5 5
1	4 121 65	1500/5 8
		For 80 x 160 mm bar
1	4 121 66	2000/5 15
1	4 121 67	2500/5 15
1	4 121 68	3000/5 20
1	4 121 69	4000/5 20

Alptec automatic power factor controllers: functionality

Technical characteristics

	Alptec 3.2/5.2/8.2	Alptec 8
Number of steps	Alptec 3.2 (up to 6 with EXT2GR/EXT3GR) Alptec 5.2 (up to 8 with EXT2GR/EXT3GR) Alptec 8.2 (up to 14 with EXT2GR/EXT3GR)	Alptec 8 (8 to 18 with EXT2GR/EXT3GR/EXT4GRS)
FRONT PANEL/CASING		
Screen	Backlit LCD with icons	Backlit graphic LCD 128 x 80 pixels
Languages	6 alarm codes (scrolling text) Italian, English, Spanish French, German, Portuguese	10 Italian, English, Spanish French, German, Czech, Polish, Russian, Portuguese and 1 customisable
IEC protection index	IP54	IP54
Extendable with modules EXT...	•	•
CONTROL/FUNCTIONS		
automatic identification of the current direction	•	•
Operation in 4 quadrants	•	•
Master/slave architecture		•
Separate input for the auxiliary power supply	•	•
Three-phase voltage control		•
Current inputs	1 (per CT, /5 A or /1 A)	3 (per CT, /5 A or /1 A)
Use of dynamic compensation (FAST)		• (with EXT4GRS)
Use with medium voltage	•	•
Separate compensation for each phase		•
Phase-neutral connection on three-phase system	•	•
Isolated RS485 communication interface	• (with EXTRS485)	• (with EXTRS485)
ETHERNET communication interface		• (with EXTETH)
Optical USB communication port on the front	• (with 4 226 87)	• (with 4 226 87)
Optical Wi-Fi communication port on the front	• (with 4 226 88)	• (with 4 226 88)
Fast current transformer programming	•	•
Configuration software and automatic distribution board test	•	•
Remote control software	•	•
Time and date (RTC) on battery for standalone operation		•
Event log: alarms, modification of settings, etc.		•
MEASUREMENT		
Rated measurement voltage	600 VAC max	600 VAC max
Voltage measurement range	50-720 VAC	50-720 VAC
Instantaneous cos ϕ (displacement factor)	•	•
Power factor - instantaneous and average weekly	•	•
Voltage and current	•	•
Reactive power to achieve the setpoint and total	•	•
Capacitor overload	•	•
Control panel temperature	•	•
Maximum voltage and current value	•	•
Maximum capacitor overload value	•	•
Maximum control panel temperature value	•	•
Active apparent power		•
Analysis of current and voltage harmonics	• up to 15th order	• up to 31st order
Measured value of each step, in VAR	•	•
Number of switching operations per step	•	•
PROTECTION		
Voltage too high and too low	•	•
Current too high and too low	•	•
Over-compensation (all capacitors disconnected and cos ϕ higher than the setpoint)	•	•
Under-compensation (all capacitors disconnected and cos ϕ lower than the setpoint)	•	•
Capacitor overload	•	•
Capacitor overload on all 3 phases		•
Overheating	•	•
Micro-power cuts	•	•
Failure of a capacitor bank	•	•
Maximum current harmonic distortion overshoot level	•	•
Programming alarm properties (activation, delay on tripping, relay excitation, etc.)		•



Alptec 3.2/5.2/8.2 and Alptec 8 automatic power factor controllers

Technical characteristics

	ALPTEC 3.2/5.2/8.2	ALPTEC 8
AUXILIARY POWER SUPPLY CIRCUIT		
Us nominal auxiliary voltage	100-440 VAC	100-415 VAC
Operating range	- 10 to + 10%	- 10 to + 10%
Nominal frequency	50 Hz or 60 Hz ~ 10%	50 Hz or 60 Hz ~ 10%
Maximum consumption	9.5 VA	27 VA
Maximum dissipation (excluding output contacts)	3.5 W bulb	4.5 W bulb
VOLTAGE CIRCUIT		
Control voltage	100-600 VAC	100-600 VAC
Operating range	50-720 VAC	50-720 VAC
Nominal frequency	50 or 60 Hz ~ 10%	50 or 60 Hz ~ 10%
Micro-cut immunity time	35 ms (110 VAC) - 80 ms (220-415 VAC)	35 ms (110 VAC) - 80 ms (220-415 VAC)
CURRENT CIRCUIT		
Nominal current Ie	Programmable 5 A/1 A	Programmable 5 A/1 A
Operating range	0.025-6 A for 5 A CT/0.025-1.2 A for 1 A CT	0.025-6 A for 5 A CT/0.025-1.2 A for 1 A CT
Constant overload	1.2 Ie	1.2 Ie
Rated short time withstand current	50 Ie for 1 s	50 Ie for 1 s
Current consumption	0.6 VA	0.6 VA
MEASUREMENT DATA		
Type of voltage/current measurement	TRMS	TRMS
Power factor adjustment	0.5 inductive to 0.5 capacitive	0.5 inductive to 0.5 capacitive
RELAY OUTPUTS		
Number of outputs	3, 5 or 8 (can be extended with EXT2GR/EXT3GR)	8 (up to 18 with EXT3GR/EXT4GRS)
Contact layout	2/4 NO (SPST) + 1 throw (SPDT)	7 NO (SPST) + 1 throw (SPDT)
IEC nominal capacity	5 A 250 V (AC1)	5 A 250 V (AC1)
Maximum capacity of the common contact terminal	10 A	10 A bulb
Maximum switching voltage	415 VAC	415 VAC
UL/CSA and IEC/EN 60947-5-1 designation	B300	B300
Electrical service life (at nominal load)	10 ⁵ cycles	10 ⁵ cycles
Mechanical life	30 x 10 ⁶ cycles	30 x 10 ⁶ cycles
SOLID STATE OUTPUTS		
Number of outputs	-	4 or 8 with EXT4GRS
CONNECTIONS		
Terminal type	Removable/plug-in	Removable/plug-in
Conductor cross-section (min./max.)	0.2-2.5 mm ² (24-12 AWG)	0.2-2.5 mm ² (24-12 AWG)
AMBIENT CONDITIONS		
Operating temperature	- 20... + 60°C	- 20... + 70°C
Storage temperature	- 30... + 80°C	- 30... + 80°C
CASING		
IEC protection index	IP54	IP54

ALPTEC 3.2/5.2 standard three-phase wiring diagram

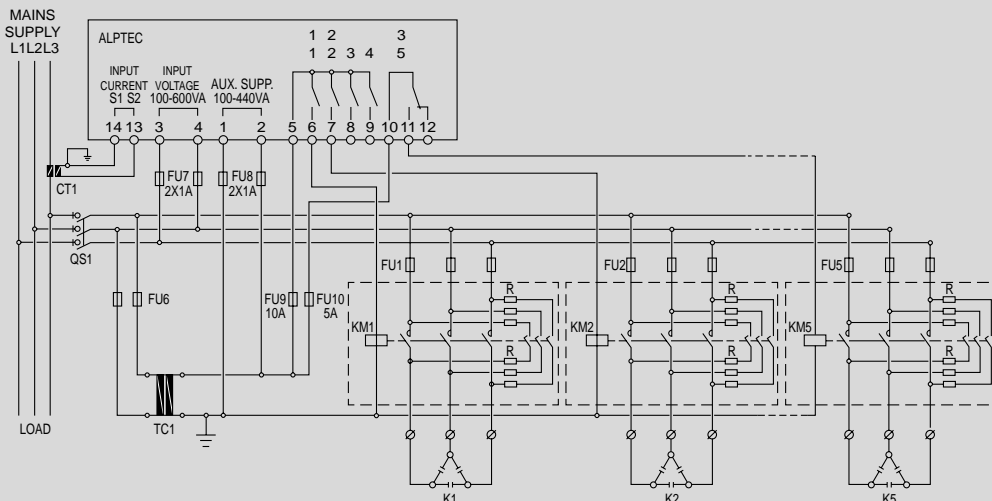

For ALPTEC 8.2 wiring diagram please consult us

Alptec 3.2/5.2/8.2 and Alptec 8 automatic power factor controllers

Current transformers

ALPTEC 8 standard three-phase wiring diagram

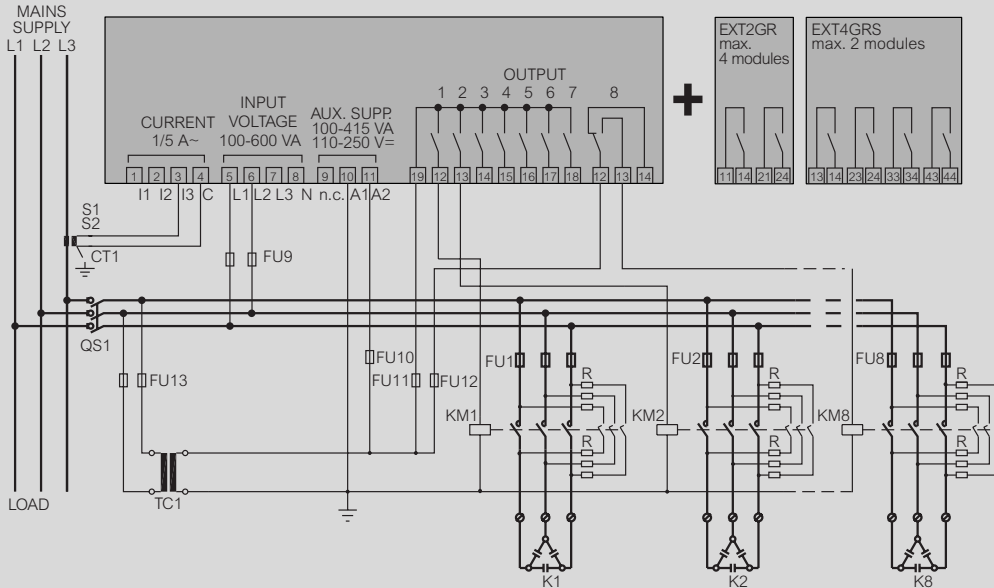

Alptec dimensions

Alptec 3.2/5.2

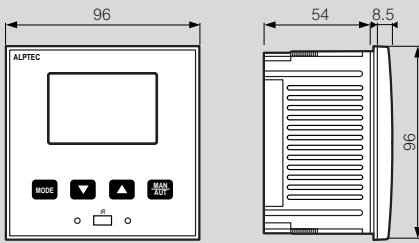

Alptec 8.2 and 8

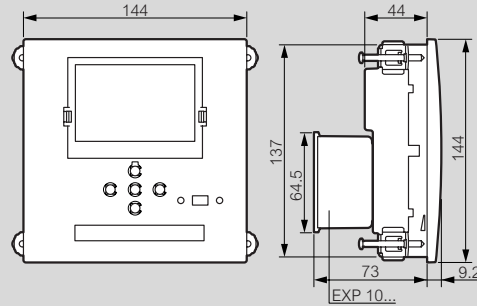

Alptec cut-out

Alptec 3.2/5.2

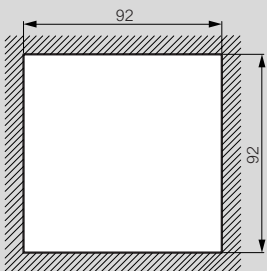

Alptec 8.2 and 8

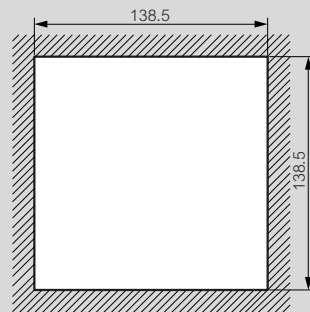

Current transformer dimensions

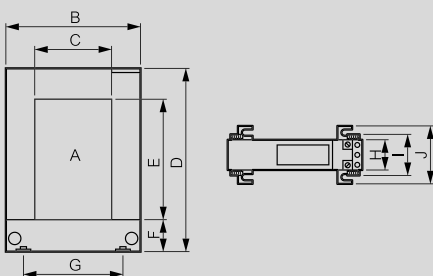

Cat.Nos	A	B	C	D	E	F	G	H	I	J
4 121 62/63	50 x 80	114	50	145	80	33	78	32	46	69
4 121 64/65	80 x 120	144	80	185	121	32	108	32	46	69
4 121/66/67/68/69	80 x 160	184	80	245	160	38	120	32	46	69



HIGH VOLTAGE OFFER

High voltage capacitors



P. 64
"All-Film"
high voltage capacitors

High voltage capacitor banks



P. 68
Types and composition
of high voltage capacitor banks

Installation examples

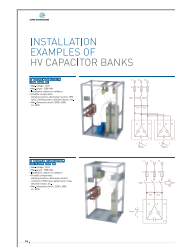

P. 74
Installation examples:
fixed type, delta
configuration

SEE THE PRODUCTS



**"All-film"
high voltage
capacitors
(p. 64)**



**High voltage
capacitor banks
(p. 68)**

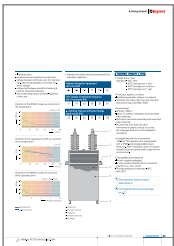

P. 64
Electrical characteristics of high voltage capacitors

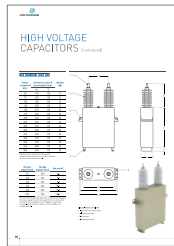

P. 66
Weights and dimensions of "All-Film" high voltage capacitors

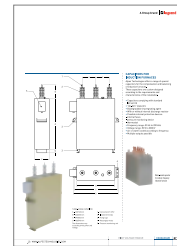

P. 67
Capacitors for induction furnaces

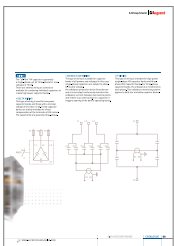

P. 69
Wiring of high voltage capacitor banks

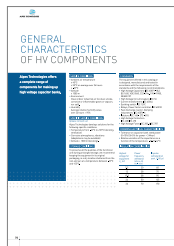

P. 70
General characteristics of high voltage capacitor banks

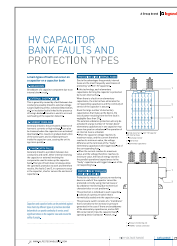

P. 71
High voltage capacitor faults and protection types

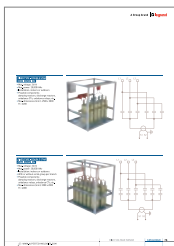

P. 75
Installation examples: fixed type, double star configuration

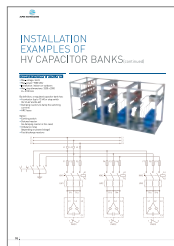

P. 76
Example of automatic installation

HIGH VOLTAGE CAPACITORS

"All-film"

"All-film" high voltage capacitors are made up of elementary or partial capacitances, generally connected in several series-parallel groups, providing the required electrical characteristics for the unit.

ADVANTAGES OF THE RANGE

- The nominal voltage of a capacitor depends on the number of groups in series
- The nominal power of a capacitor depends on the number of partial capacitances in parallel per group

Each elementary capacitance is made of two sheets of aluminium foil forming the reinforcements or the electrodes, and special high quality polypropylene film which is rough to assist impregnation, forming part of the insulation.

This wired capacitance assembly, referred to as the "active part", is positioned in a stainless steel case, which has insulated porcelain terminals or bushings at the top for connecting the device.

After the "active part" has been dried and treated, it is impregnated under vacuum with a liquid dielectric of the following type:

- non-chlorinated
- non-toxic
- biodegradable

With the polypropylene film, this liquid dielectric, which has a remarkably high chemical stability, a high gas absorption capacity and a high partial discharge extinction capacity (discharges for which the flash point is approximately 150°C), ensures total insulation between electrodes. This "all-film" capacitor technology has the following main characteristics:

- Excellent resistance to strong electrical fields
- Very low power losses, leading to considerable savings for high power capacitor banks

ELECTRICAL CHARACTERISTICS

Synthetic "all-film" type dielectric capacitors, compared with the previous generation of "mixed" (paper + film) capacitors, have a much longer service life, due to:

- Their excellent thermal stability related to very low power losses, due to the removal of the paper
- The remarkable chemical stability of the liquid dielectric, giving:
 - high partial discharge absorption capacity
 - high dielectric resistance to transient overcurrents and overvoltages
 - very low variation of capacitance as a function of temperature

- Average loss factor:
 - 0.15 W/kVar at power-up
 - 0.1 W/kVar after 500 hours' operation

- Variation of the capacitance as a function of the temperature:
 - average: $2 \times 10^{-4}/^{\circ}\text{C}$

- Internal discharge device:
 - internal discharge resistors reducing the residual voltage to 75 V in 10 minutes after disconnection of the supply

- Frequency:
 - standard: 50 Hz (60 Hz on request)

- Reference standards:
 - French: C 54 102
 - international: IEC 60 871.1 and 2 (supply capacitors) IEC 60 110 (capacitors for air or water cooled induction furnaces)
 - German: VDE 0560/4, VDE 0560/9
 - British: BS 1650
 - other standards on request

- Permissible overloads
 - current: up to 1.3 I_n
 - voltage (between terminals):
 - 1.1 U_n 12 hrs/24 hrs,
 - 1.15 U_n 30 minutes/24 hrs,
 - 1.2 U_n 5 minutes/24 hrs,
 - 1.3 U_n 1 minute/24 hrs.



- Individual tests
 - measurement of capacitance and losses
 - voltage between terminals test:
 - 2 U nominal 10 s. alternating voltage,
 - 4 U nominal 10 s. direct voltage
 - voltage test between joined terminals and earth at industrial frequency
 - test of discharge device and seal-tightness of the case

Variation of the W/kVar losses as a function of the temperature

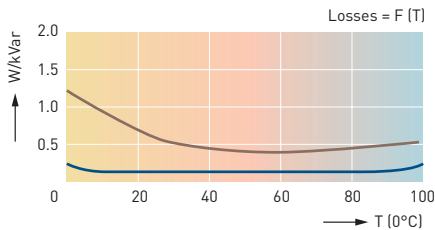

Variation of the capacitance C (μF) as a function of the temperature

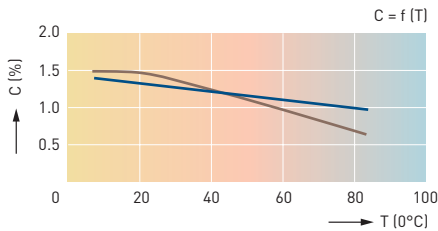

Variation of the W/kVar losses as a function of the operating time

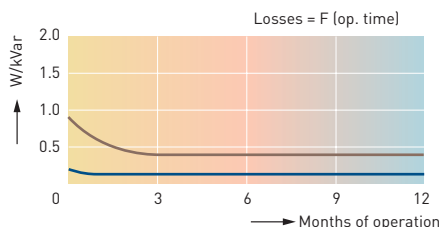

— Mixed dielectric
— All-film dielectric

- Standard insulation levels (phases/earth) for individual capacitors

Highest voltage for equipment
Um (rms) (kV)

2.4	3.6	7.2	12	17.5	24
-----	-----	-----	----	------	----

Test voltage at industrial frequency
(for 10 seconds) (kV)

8	10	20	28	38	50
---	----	----	----	----	----

- Lightning impulse withstand voltage
(peak value) (kV)

35	40	60	75	95	125
----	----	----	----	----	-----

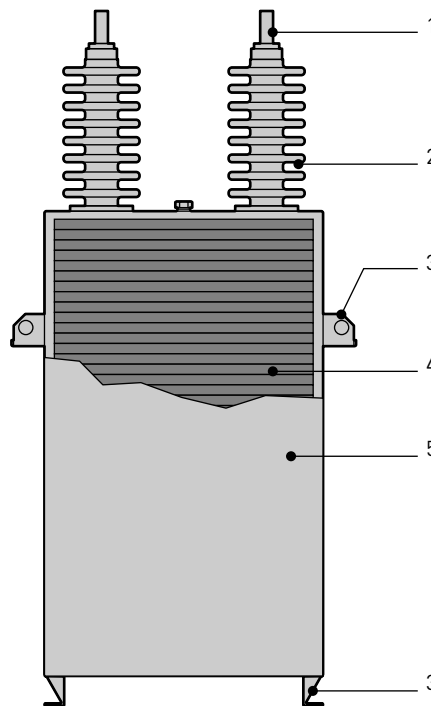

- 1 - Connection
- 2 - Porcelain terminal
- 3 - Fixing lug
- 4 - Stainless steel case
- 5 - Active part

INSTALLATION CONDITIONS

- Temperature class
 - Standard: - 25/+ 45°C :
 - 45°C average over 1 hour
 - 40°C average over 24 hours
 - 30°C average over 1 year
- Protection against corrosion
 - Installation possible: indoor or outdoor
 - Stainless steel case, with one coat of primer and several top coats (RAL 7033)
- Environment
 - Altitude <1000 m
 - Indoor or outdoor installation to be specified when ordering
 - Vertical or horizontal mounting to be specified when ordering
 - Dry and free from dust (for other environments please consult us so that the creepage distances can be adapted if necessary)
- Compatibility with the environment
 - "All-film" HV capacitors are impregnated with a (PCB-free) biodegradable liquid dielectric. Their installation does not require any particular precautions with regard to the environment.
- Storage/Recommendations
 - In their original packaging
 - In a dry location sheltered from inclement weather (sun, rain, snow)
 - Storage temperature between -40°C and +60°C

⊕ Other temperature classes on request, please consult us

⊕ For HV capacitor faults and protection types, see p. 71

HIGH VOLTAGE CAPACITORS (continued)

WEIGHTS AND DIMENSIONS

Power (standard) kVar	Dimensions (non-contractual) (mm)		Weight (kg)
	Hc	D	
50	190	135	17
75	250	135	21
100	280	135	23
125	350	135	27
150	370	135	30
175	450	135	33
200	460	135	35
250	460	135	42
300	510	175	46
350	590	175	53
400	650	175	60
450	730	175	65
500	790	175	70
550	880	175	76
800	950	175	82

NB: Given the multiplicity of HV capacitor voltages, these dimensions must be confirmed by our technical departments.

Hb type indoor (mm)	Hb type outdoor (mm)	Um rms kV
75	235	2.4
160	235	3.6
160	235	7.2
160	235	12.0
235	235	17.5
265	265	24.0

The Um rms voltage to be taken into account is the voltage of the mains supply to which the capacitor is to be connected, not the nominal voltage of the unit (applies in particular to single-phase capacitors wired in star or double star configurations).

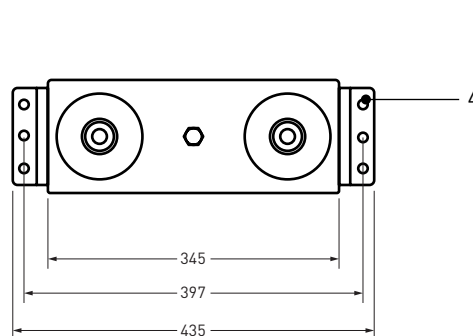
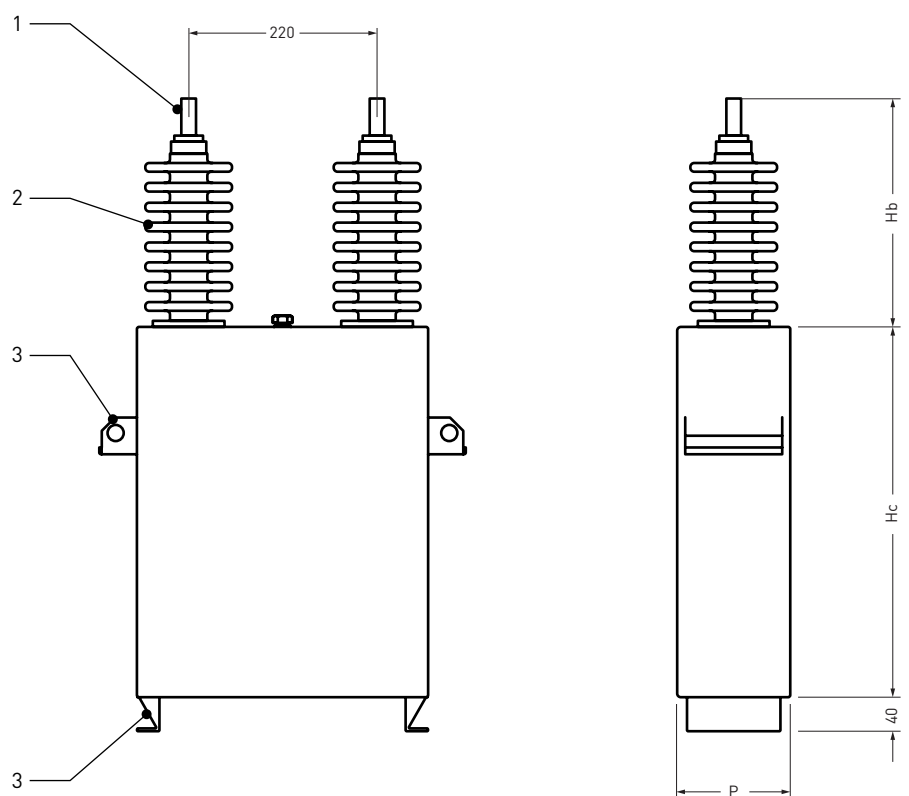

- SINGLE-PHASE CAPACITOR
- 1 - Connection \varnothing = M12 or M16
 - 2 - Isolated terminals
 - 3 - Fixing lugs
 - 4 - Rectangular holes

CAPACITORS FOR INDUCTION FURNACES

Alpes Technologies offers a range of special capacitors for the compensation and balancing of induction furnaces. These capacitors are custom designed according to the requirements and characteristics of the installation.

- Capacitors complying with standard IEC 60110
- "All-film" dielectric
- Biodegradable impregnating agent
- With or without internal discharge resistor
- Possible internal protection devices:
 - internal fuses
 - pressure monitoring device
 - thermostat
- Frequency range: 50 Hz to 200 kHz
- Voltage range: 50 V to 3000 V
- Air or water cooled according to frequency
- Multiple outputs possible



Water-cooled capacitor for medium frequency induction furnaces

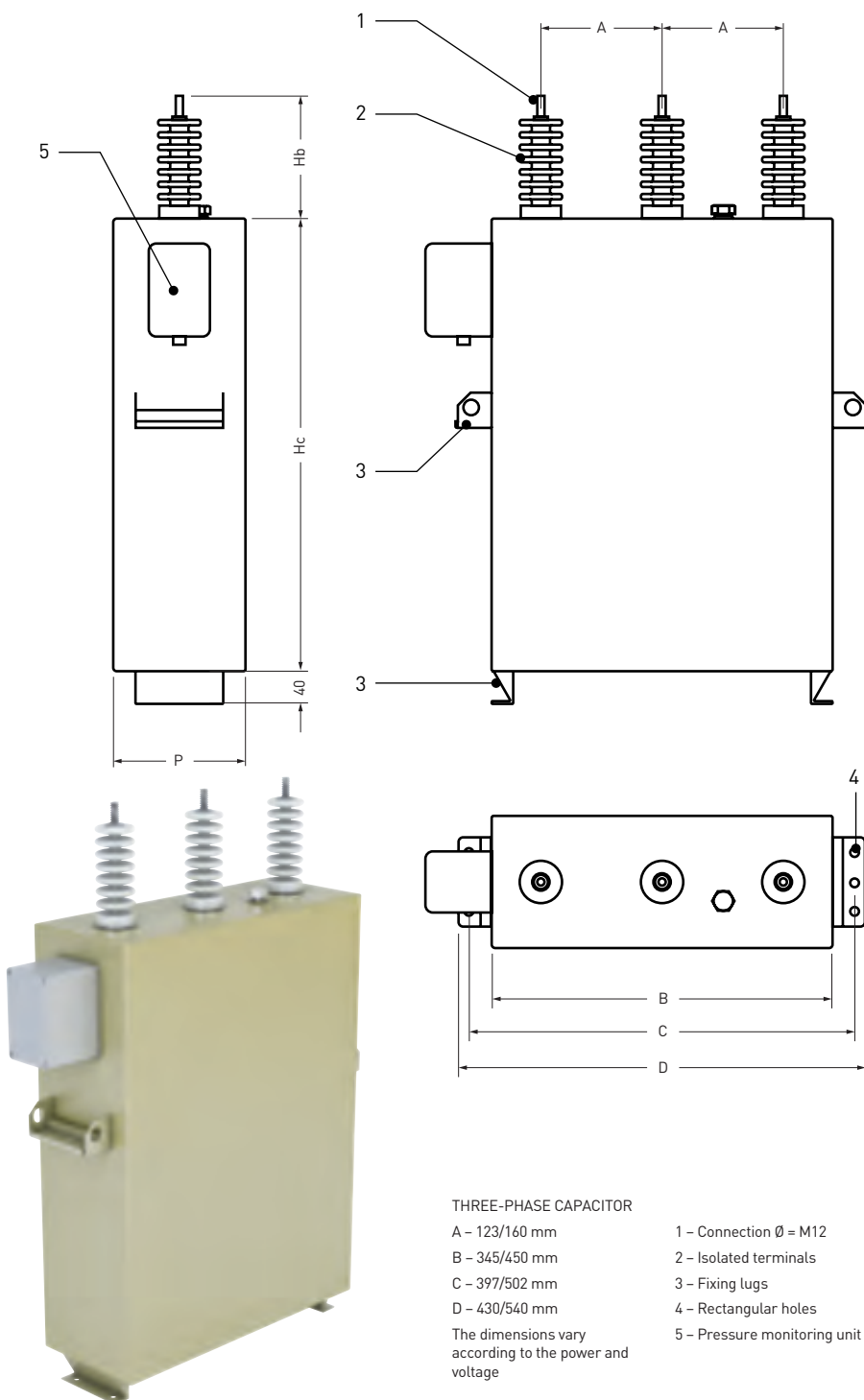



CAPACITOR BANKS

High Voltage

Alpes Technologies offers you bespoke solutions in order to adapt to your installation and your requirements.

CAPACITOR BANK TYPE

A capacitor bank is generally made up of several individual single or three-phase capacitors, assembled together and interconnected to create high power assemblies called "capacitor banks".

ALPES TECHNOLOGIES designs and manufactures various different types of capacitor banks, defined by:

- The total reactive power to be installed
- The nominal supply voltage
- The altitude and ambient temperatures
- Electrical constraints:
 - presence of harmonics,
 - automatic capacitor banks with power factor controller
- Installation
 - indoor (in an electrical room)
 - outdoor (in a substation)
 - dusty environments
- Operator safety
 - IP 00 open rack
 - IP 21 cubicle (indoor installation)
 - IP 23 cubicle (outdoor installation)
 - double overhanging roof
 - IP 54 cubicle
 - other degrees of protection on request

COMPOSITION

A capacitor bank can be made up of the following components:

- Additional accessories (discharge reactors, damping reactors and detuned reactors) [see p. 73](#)
- Built-in electrical protection devices (HRC fuses, unbalance protection devices, etc.) [see p. 71](#)
- Switching appliances (earthing switch, switches, contactors, etc.)
- Power factor controllers for automatic capacitor banks [see p. 57](#)

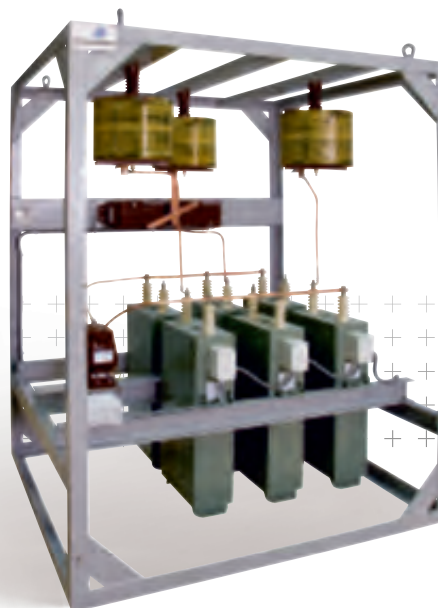

WIRING

The "all-film" HV capacitor is generally a single-phase unit (or three-phase for max. voltages of 12 kV). There are several wiring or connection methods for combining individual capacitors to create high power capacitor banks.

• **DELTA WIRING**

This type of wiring is used for low power capacitor banks and those with a nominal voltage of less than 12 kV. These capacitor banks are mainly intended for direct compensation at the terminals of HV motors. The capacitor(s) are generally three-phase.

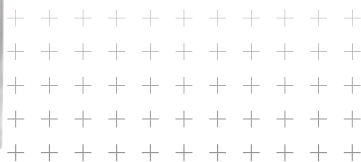
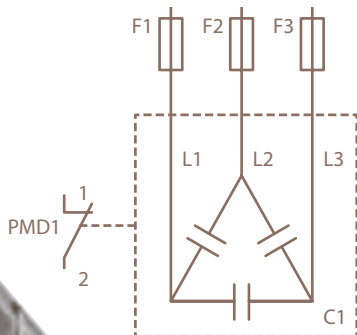

• **DOUBLE STAR WIRING**

The type of wiring is suitable for capacitor banks of all powers and voltages (in this case single-phase capacitors are subject to phase-to-neutral voltage).

An unbalance protection device (transformer and current relay) continuously monitors the unbalance current, between two neutral points, and if there is an internal fault in a capacitor it triggers opening of the bank's operating device.

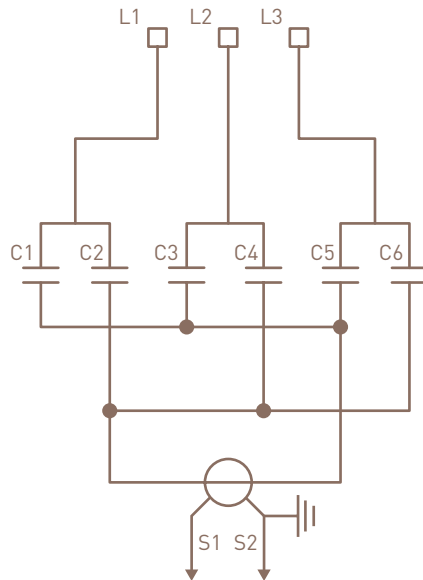

• **H WIRING**

This type of wiring is intended for high power single-phase HV capacitor banks and three-phase VHV capacitor banks. For three-phase capacitor banks, the unbalance is monitored on each phase. This unbalance monitoring system applies to both star and delta capacitor banks.

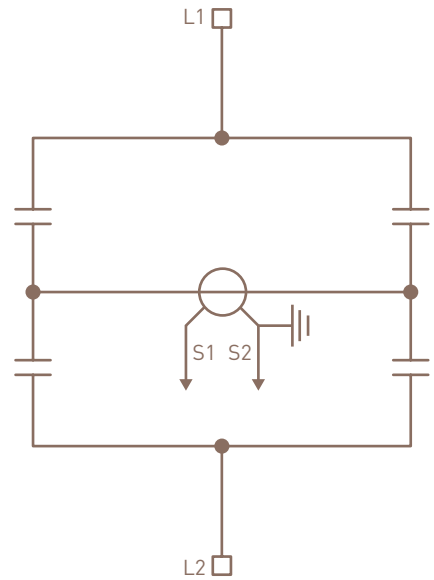

GENERAL CHARACTERISTICS OF HV COMPONENTS

Alpes Technologies offers a complete range of components for making up high voltage capacitor banks.

SERVICE CONDITIONS

- Ambient air temperature
 $\leq 40^{\circ}\text{C}$
 $\leq 30^{\circ}\text{C}$ on average over 24 hours
 $\geq -25^{\circ}\text{C}$
- Altitude
 $\leq 1000\text{ m}$
- Environment
 Clean indoor industrial air (no dust, smoke, corrosive or inflammable gases or vapours, nor salt).
- Humidity
 Average relative humidity value, over 24 hours $< 95\%$

SPECIFIC SERVICE CONDITIONS

(please consult us)

Alpes Technologies develops solutions for the following specific conditions:

- Temperature from -40°C to $+50^{\circ}\text{C}$ (derating, ventilation)
- Corrosive atmospheres, vibrations (adaptations may be available)
- Altitude $> 1000\text{ m}$ (derating).

STORAGE CONDITIONS

To preserve all the qualities of the functional unit during prolonged storage, we recommend keeping the equipment in its original packaging, in a dry location sheltered from the rain and sun at a temperature between -25°C and $+55^{\circ}\text{C}$.

STANDARDS

The equipment offered in this catalogue is designed, manufactured and tested in accordance with the requirements of the standards and the following recommendations:

- High Voltage Capacitors: IEC 60871-1&2, BS 1650, VDE 0560, C22-2 No. 190-M1985, NEMA CP1
- High Voltage Circuit breakers: IEC 56
- Current transformers: IEC 60044
- Earthing switch: IEC 129C
- Relays, Power factor controller: IEC 60010
- Fast discharge reactor, Damping inductances: IEC 60076-6
- Isolators: IEC 168 - 273 - 815
- High Voltage Contactors: IEC 420/IEC 470
- High Voltage Fuses: IEC 282.1/IEC 787

COMMON ELECTRICAL CHARACTERISTICS

- Tolerance on capacitor bank rated power: $0/+10\%$ ($0/+5\%$ for power $> 3\text{ Mvar}$)
- Relative variation of the capacitance as a function of the temperature: $-3.5.10^{-4}/^{\circ}\text{C}$

INSULATION COORDINATION

Highest voltage for equipment U_m (kV)	Power frequency withstand (kVrms, 50 Hz-1 min)	Impulse withstand (kV peak, 1.2/50 μs)
7.2	20	60
12	28	75
17.5	38	95
24	50	125
36	70	170

HV CAPACITOR BANK FAULTS AND PROTECTION TYPES

4 main types of faults can occur on a capacitor or a capacitor bank

1. BREAKDOWN

Breakdown of a capacitor component due to an internal short-circuit.

2. EXTERNAL SHORT-CIRCUIT

This is generally caused by a fault between live conductors possibly linked to external voltage surges (lightning strike, activation/deactivation, etc.) or insulation faults linked to the presence of foreign bodies. It results in electric arcs and overheating of the capacitor dielectric.

3. CURRENT OVERLOAD

Generally linked to the permanent presence of harmonic currents or high voltage. It can also be transient when the capacitors are activated/deactivated. This results in gradual destruction of the active parts and increased pressure inside the capacitor case, causing the unit to age more quickly.

4. PHASE-EARTH FAULT

Generally linked to a problem between live conductors and earth, either internal involving the capacitor or external involving the components used to make up the capacitor bank. This type of fault does not always allow the upstream protection to work and therefore results, like faults 2 and 3, in a pressure surge in the capacitor, shorter service life and loss of capacitance.

Capacitors and capacitor banks can be protected against these faults by different types of protection described below which can provide continuity of service, avoid significant stress on the capacitor case and ensure the safety of people.

PROTECTION USING INTERNAL FUSES

Due to the advantages they provide, internal fuses are the most frequently used means of protecting "all-film" HV capacitors.

In this technology, each elementary capacitance forming the capacitor is protected by its own internal fuse.

When there is a fault on an elementary capacitance, the internal fuse eliminates the corresponding capacitance and the continuity of service of the capacitor is assured.

Given the large number of elementary capacitances that make up the device, the loss of power resulting from the first fault is negligible (less than 2%).

The external unbalance protection will only be activated if a large number of "broken down" elementary capacitances in one capacitor may cause too great an unbalance. The operation of an internal fuse is activated:

- When the capacitor voltage reaches its maximum value, and the current therefore reaches its minimum value, the voltage difference at the terminals of the "faulty" elementary capacitance will trigger blow-out of the corresponding fuse.
- When the current reaches its maximum value, and the voltage therefore reaches its minimum value, the flow of energy stored in the parallel operational capacitances to the "faulty" capacitance will trigger blow-out of the corresponding fuse.

PROTECTION BY PRESSURE MONITORING DEVICE

Protection by means of a pressure monitoring device is useful if the capacitor cannot be protected correctly using internal fuses or by unbalance monitoring (due to electrical characteristics or cost problems).

This protection is individual to each capacitor. It consists of a pressure switch that is hermetically sealed onto the capacitor case.

This pressure switch consists of a "membrane" that is sensitive to the increase in pressure generated in the case if there are breakdowns of the elementary capacitances, and an NC/NO contact which trips the capacitor bank's operating device (contactor - switch, etc.)

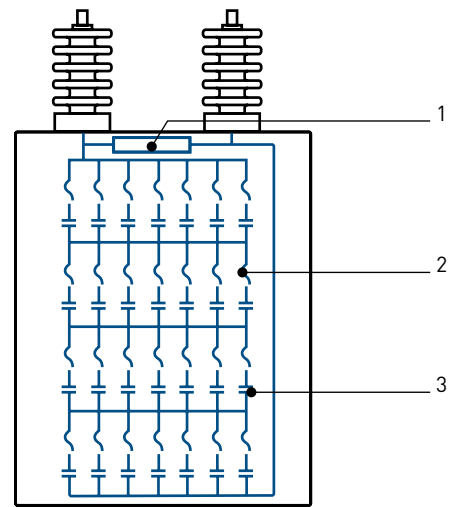

Internal view of an "all-film" HV capacitor with internal fuses

- 1 - Discharge resistor
- 2 - Internal fuse
- 3 - Elementary capacitance

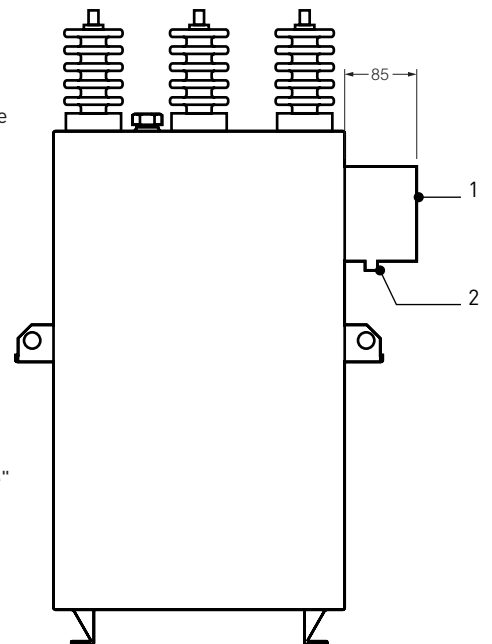

- 1 - Pressure monitoring unit
- 2 - "NO/NC" contact connection

EXTERNAL PROTECTION DEVICES USED WITH HV CAPACITORS

In addition to the protection devices specific to each capacitor (internal fuses or pressure monitoring devices), other accessories must be used and an associated external protection device incorporated in the capacitor bank. The most commonly used external protection devices are: HRC fuses and unbalance protection devices.

The choice between these various options is dependent on the following criteria:

- Electrical characteristics of the capacitor (power, voltage, connection)
- Customer's requirements concerning the sensitivity of the protection device

There are four protection options for "all-film" HV capacitors:

- Without internal fuses and external protection by unbalance monitoring
- With internal fuses and external protection by unbalance monitoring
- Without pressure monitoring device and external protection by HRC fuses
- With pressure monitoring device and external protection by HRC fuses

The table opposite gives the possible type of protection for the capacitor and its advantages, according to the above criteria.

HRC FUSES

Protection using HRC fuses integrated in the capacitor bank is ideal (technically and economically) for capacitor banks with the following characteristics:

- low power (< 1200 kVar)
- those equipped with three-phase connection capacitors (see delta wiring, p. 55)
- supply voltage less than 12 kV

The rating of the HRC fuses should be selected to have a value between 1.7 and 2.2 times the nominal current of the capacitor bank.

HRC fuse blow-outs are generally caused by a dead short inside the capacitor. Operation of the fuses will depend on the number of groups in series that are damaged inside the capacitor.



As an option, it is possible to add blown fuse contacts to feed back information or trip an operating device (circuit breaker, switch, contactor, etc.).

UNBALANCE OR DIFFERENTIAL PROTECTION

This protection generally applies to capacitor banks with the following characteristics:

- Medium or high power (> 1000 kVar)
- Those with single-phase connection capacitors - Mains voltage greater than 12 kV

Unbalance or differential protection is sensitive, capable of detecting and reacting to a partial fault in a capacitor.

It consists of a current transformer connected between the two neutral points in the double star, combined with a current relay. When there is a fault in a capacitor there is an unbalance and therefore a current circulating in the current transformer which will cause, by means of the relay, the bank's operating device (circuit breaker, switch, contactor, etc.) to open.

 This protection does not apply to three-phase capacitors.

Capacitor power and voltage	Capacitor connection	Capacitor protection	Associated external protection	Advantages
All powers and all voltages	Single-ph.	Without internal fuse	Unbalance	
$P \geq 200$ kVar and $U \leq 13$ kV	Single-ph.	Without internal fuses	Unbalance	<ul style="list-style-type: none"> • Does not trip on 1st fault • Assured continuity of service
All powers and $U \leq 12$ kV	Three-ph.	Without pressure monitoring device	HRC fuses	
All powers and $U \leq 12$ kV	Three-ph.	With pressure monitoring device	HRC fuses	<ul style="list-style-type: none"> • No risk of case rupturing

OPERATING AND PROTECTION COMPONENTS AND DEVICES

DAMPING REACTORS

Damping switching currents

Installing single-phase damping reactors in series on each phase of the capacitor bank makes it possible to reduce the switching currents to values that are acceptable for the corresponding operating device. These are necessary in the following situations:

- step capacitor banks
- mains short-circuit power very high in relation to the power of the capacitor bank to be connected
- frequent control operations of the capacitor bank

DETUNED REACTORS

Protecting capacitors against harmonics

For mains supplies with a high level of harmonic interference, installing a detuned reactor, generally three-phase and connected in series with the capacitor bank, is the only effective protection. The detuned reactor performs a dual role:

- Increasing the capacitor impedance in relation to the harmonic currents
- Shifting the parallel resonance frequency of the source and the capacitor to below the main frequencies of the harmonic currents that are causing interference. This prevents amplification of the harmonic voltages already present on the network

 The detuned reactor also performs the functions of a damping reactor.

There are 3 main types of detuned reactor:

"resin-impregnated"

- Indoor installation
- IP 00
- Max. voltage 24 kV
- Connection on copper lug
- Three-phase
- Optional rollers for easier installation

"oil-immersed"

- Indoor or outdoor installation
- IP 00 or IP 55
- Max. voltage 36 kV
- Connection on porcelain terminals or plug-in terminals
- Three-phase
- Protection by DGPT2 type relay
- Rollers for easier installation

"resin-impregnated air reactors" (this type is mainly for use on VHV supplies)

- Outdoor installation
- IP 00
- Max. voltage 170 kV
- Single-phase

FAST DISCHARGE REACTORS

Operator protection

Installing two fast discharge reactors or voltage transformers between the phases of the capacitor bank reduces the capacitor discharge time from 10 minutes to approximately 10 seconds.

This reduced discharge time:

- Provides safety for staff when carrying out work
- Reduces waiting time before earthing (closing of the earthing switch)
- Makes it possible to reactivate the capacitor banks in steps more quickly after breaking, although a minimum time of 15 minutes between two discharges is essential, to ensure correct cooling of the reactors

OTHER POSSIBLE COMPONENTS

- Unbalance relay – Protection of capacitors wired in double star configuration
- Earthing switch
- Switch (optionally motorised)
- Circuit breaker (optionally motorised)
- Power factor controller to control automatic capacitor banks

 ALPTEC power factor controllers – Control of capacitor steps, see p. 57

The operating and protection equipment (circuit breaker, fuse, switch, contactor) of a high voltage capacitor bank must take the following three requirements into account:

- Capacity to withstand high transient currents when activated
- Capacity to ensure breaking on opening without restriking (at the moment of breaking, the capacitor bank may be loaded at full voltage)
- Capacity to withstand a permanent rms current corresponding to at least 1.43 times the nominal 50 Hz current of the capacitor bank in steady state. Vacuum break operating devices, or those in SF₆, are ideal for operating and protecting capacitor banks.

The ALPES TECHNOLOGIES Technical Departments can advise you on the selection of a suitable operating and protection device for your capacitor bank.

INSTALLATION EXAMPLES OF HV CAPACITOR BANKS

FIXED TYPE - DOUBLE DELTA CONFIGURATION

- Max. voltage: 12 kV
- Max. power: 1500 kVAr
- Installation: indoor or outdoor
- Possible components: damping reactors, discharge reactors, HRC fuses, earthing switch, detuned reactor, etc.
- Max. dimensions (mm): 2000 x 2000
H = 2200

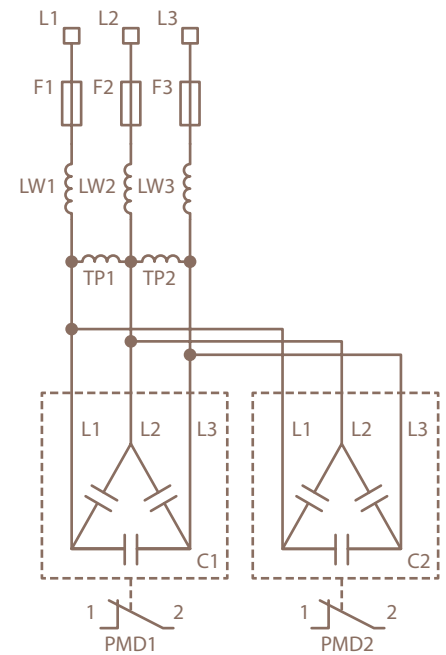
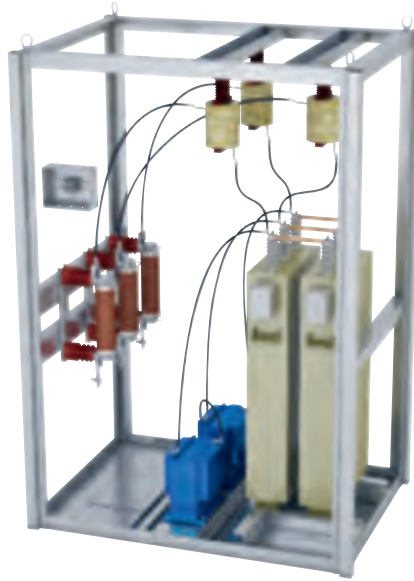

FIXED TYPE WITH CONTACTORS - DELTA CONFIGURATION

- Max. voltage: 12 kV
- Max. power: 1500 kVAr
- Installation: indoor or outdoor
- Possible components: damping reactors, discharge reactors, contactors, HRC fuses, power factor relay, detuned reactor, etc.
- Max. dimensions (mm) : 2000 x 2000
H = 2200

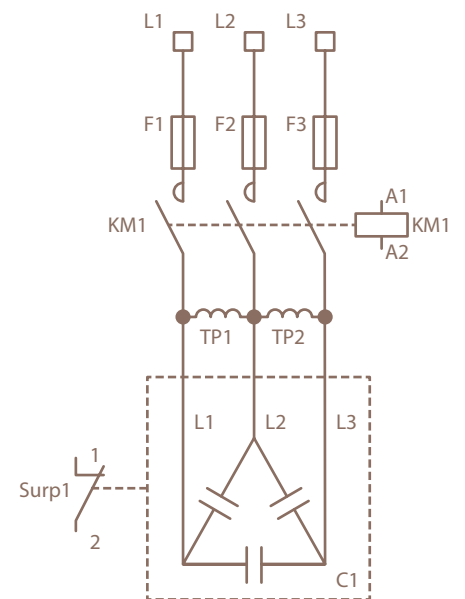
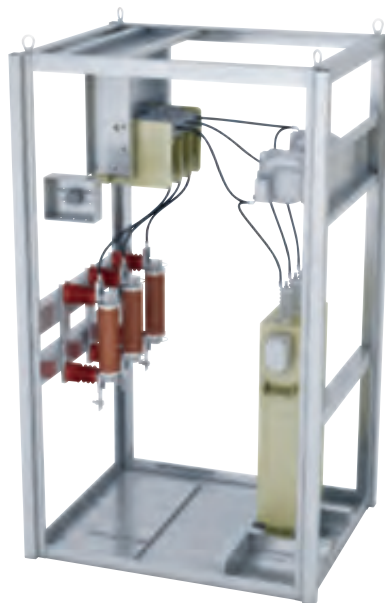

FIXED TYPE - DOUBLE STAR CONFIGURATION

- Max. voltage: 24 kV
- Max. power: 20,000 kVAr
- Installation: indoor or outdoor
- Possible components: damping reactors, discharge reactors, unbalance CTs, unbalance relays, etc.
- Max. dimensions (mm) : 2500 x 2000
H = 2200

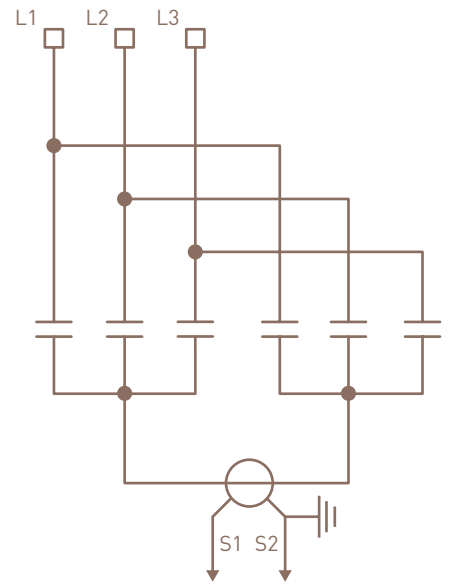

FIXED TYPE - DOUBLE STAR CONFIGURATION

- Max. voltage: 36 kV
- Max. power: 20,000 kVAr
- Installation: indoor or outdoor
- With or without serial group per branch
- Possible components: damping reactors, discharge reactors, unbalance relays, unbalance CTs, etc.
- Max. dimensions (mm): 3500 x 2000
H = 4000

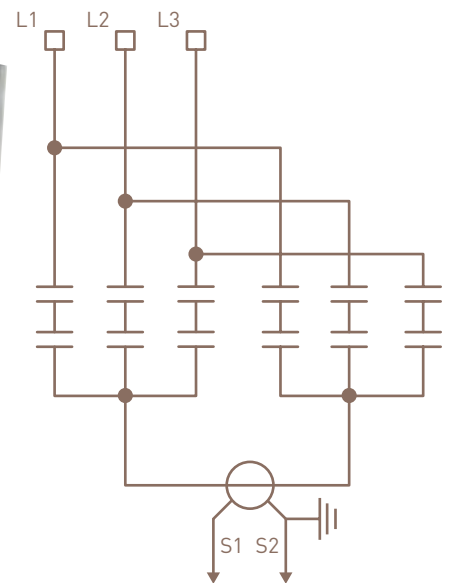
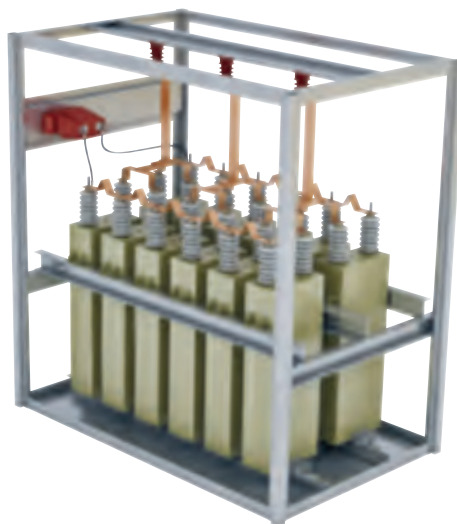

INSTALLATION EXAMPLES OF HV CAPACITOR BANKS (continued)

EXAMPLE OF AUTOMATIC INSTALLATION

- Max. voltage: 36 kV
- Max. power: 9000 kVAr
- Installation: indoor or outdoor
- Max. step dimensions: 3200 x 2000
H = 2100 mm

By definition, a regulated capacitor bank has:

- A contactor (up to 12 kV) or step switch (for 24 kV and 36 kV)
- Damping reactors to damp the switching currents
- HRC fuses

Option:

- Earthing switch
- Detuned reactor (no damping reactor in this case)
- Unbalance relay (depending on power/voltage)
- Fast discharge reactors

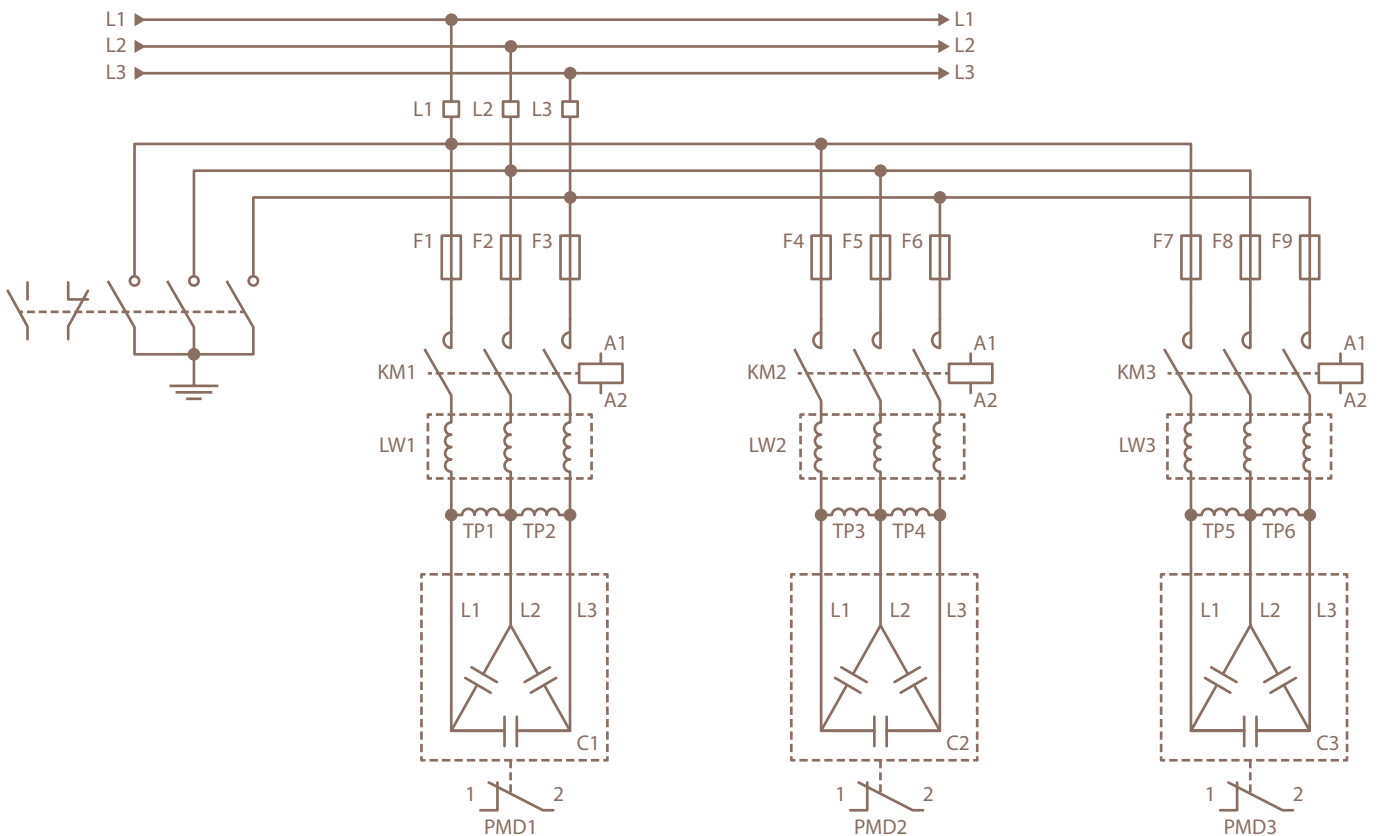
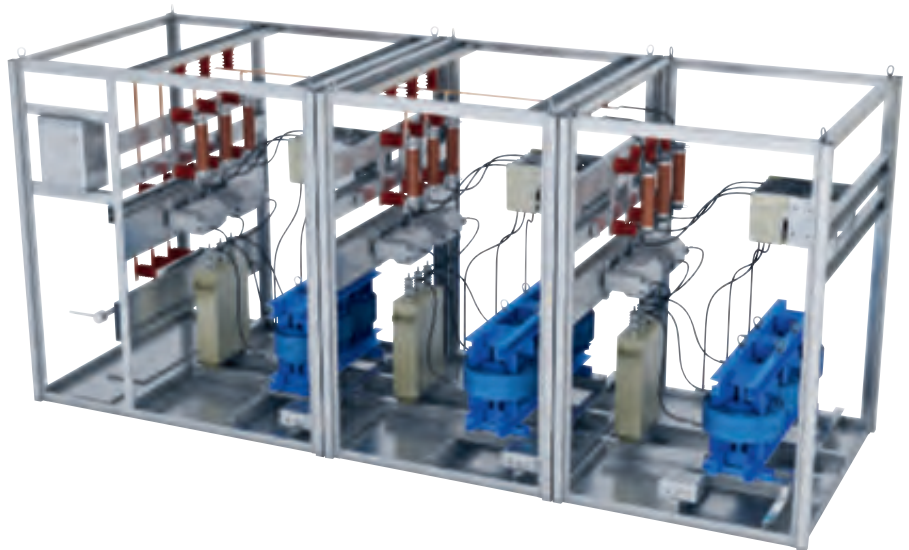

APPENDICES

PHASE SHIFT - LOAD TYPES

PHASE SHIFT

In an AC electrical installation, depending on the type of electrical load (resistive, inductive, capacitive), a phase shift of varying size occurs between the current and the voltage. The symbol for this phase shift is "φ".

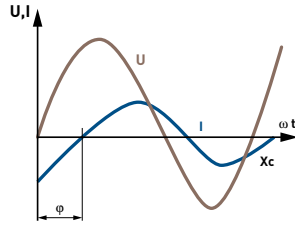

LOAD TYPES

Resistive loads consist of pure R resistors. For this type of load, the current generated is in phase with the voltage.

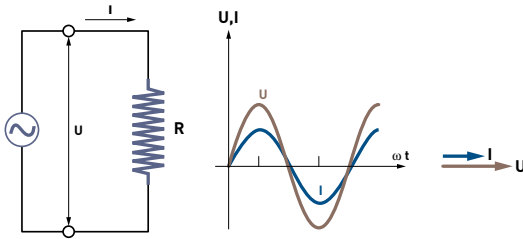

Inductive loads consist of inductances, such as asynchronous motors and ballasts in fluorescent tubes.

If we consider a purely inductive load L, the current generated always lags 90° behind the voltage.

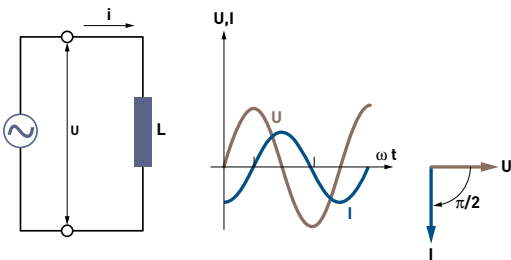

Capacitive loads always consist of capacitors, mainly capacitor banks.

If we consider a purely capacitive load C, the current generated always leads the voltage by 90°.

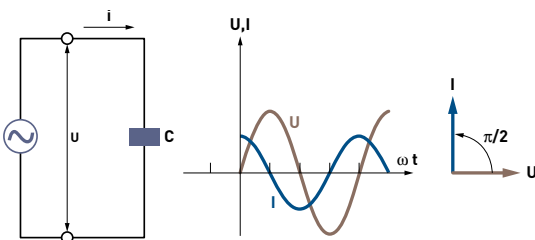

ACTIVE, REACTIVE AND APPARENT POWERS

Electrical powers are made up as follows:

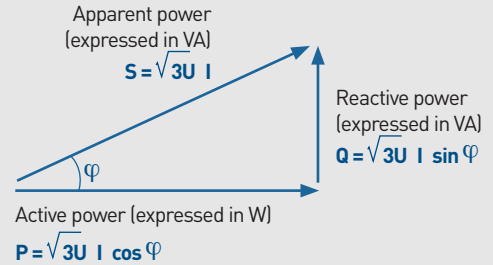

φ : voltage/current displacement angle

POWER FACTOR

This corresponds to the active power/apparent power ratio, therefore if we assume that the current and the voltage are perfectly sinusoidal without interference, it equals PF = cos (φ).

ACTIVE POWER

This is what causes, for example, a movement in the case of a motor, or a release of heat in the case of a resistive load; it could be termed "useful" power. The unique property of active power is to make work. A load draws active power when the current is in phase with the voltage. Active power is expressed in watts (W).

REACTIVE POWER

This is not strictly speaking a power, since work cannot be obtained from it as it can with active power. Reactive power Q is defined compared to active power P.

$$P = \sqrt{3} UI \cos \varphi$$

$$Q = \sqrt{3} UI \sin \varphi$$

With a single-phase supply, the $\sqrt{3}$ disappears

Purely resistive devices are the only ones that do not consume reactive energy.

ACTIVE ENERGY

In physics, this represents the ability of a system to produce work, which could involve movement, light, heat or even electricity.

Energy is expressed in joules (SI unit), but often in kilowatts per hour (KWh).

Energy is therefore the consumption of a system producing work for one hour.

Active energy = Ea = consumption = active power x time

ACTIVE, REACTIVE AND APPARENT POWERS (CONTINUED)

REACTIVE ENERGY

This is used in particular in the windings of motors and transformers to create the magnetic field without which they would not be able to operate. It corresponds to the reactive power Q (kVAR).

Energy is expressed in kilovar per hours (kVAh). Unlike active energy, reactive energy is said to be "unproductive" for the user.

Reactive energy = E_r = reactive power x time

APPARENT ENERGY

This is the resultant vector of the active and reactive energy.

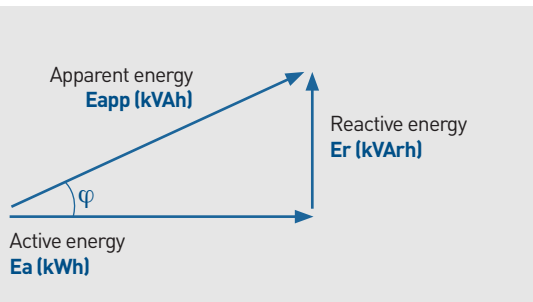

POWER FACTOR OF THE MAIN RECEIVERS

The following receivers consume the most reactive energy:

- Motors at low load
- Welding machines
- Arc and induction furnaces
- Power rectifiers

RECEIVER	COS φ	TG φ
	0%	5.80
	25%	1,52
Ordinary asynchronous motors loaded at	50%	0,94
	75%	0,75
	100%	0,62
Incandescent bulbs	approx. 1	approx. 0
Fluorescent bulbs	approx. 0.5	approx. 1.73
Discharge lamps	0.4 to 0.6	approx. 2.29 to 1.33
Resistance furnaces	approx. 1	approx. 0
Compensated induction furnaces	approx. 0.85	approx. 0.62
Dielectric heating furnaces	approx. 0.85	approx. 0.62
Resistance welding machines	0.8 to 0.9	0.75 to 0.48
Single-phase static arc welding stations	approx. 0.5	approx. 1.73
Arc welding transformers-rectifiers	0.7 to 0.9	1.02 to 0.48
	0.7 to 0.8	1.02 to 0.75
Arc furnaces	0.8	0.75
Thyristor power rectifiers	0.4 to 0.8	2.25 to 0.75

HARMONICS

In recent years, the modernisation of industrial processes and the sophistication of electrical machines and equipment have led to major developments in power electronics: These systems represent "non-linear" loads for electrical supplies.

LINEAR LOADS

A load is said to be "linear" if the current it draws is sinusoidal when it is powered by a sinusoidal voltage.

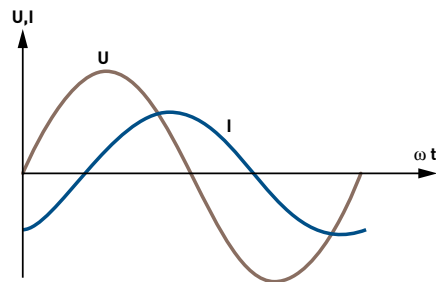

This type of receiver does not generate harmonics.

NON-LINEAR LOADS

A load is said to be "non-linear" if the current it draws is not sinusoidal when it is powered by a sinusoidal voltage. Non-linear loads distort the electrical signals of the current and the voltage.

This type of receiver does generate harmonic currents.

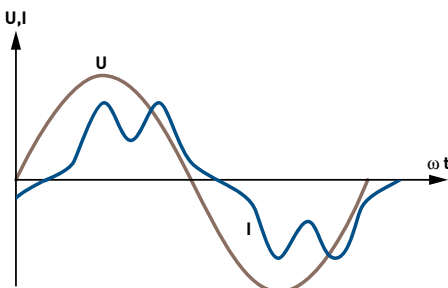

Type of non-linear load:

- Examples of single-phase loads: Low voltage (energy saving) bulb, fluorescent tube, electronic ballast, medical equipment, television sets, computers, printers, photocopiers, inverters, etc.
- Examples of three-phase loads: Variable speed drives for motors, rectifier (AC-DC converter), welding machine, arc furnace used in metallurgy, battery charger, PLC, UPS, etc.

These non-linear loads inject currents with a non-sinusoidal waveform onto the supply. These currents are formed by a fundamental component of the supply frequency, plus a series of superimposed currents, multiple frequencies of the fundamental which are known as harmonics.

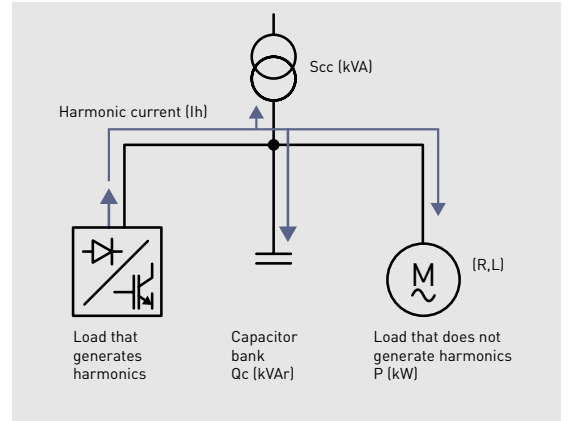

EFFECTS OF HARMONICS

The immediate effects of harmonics (losses due to Joule effect):

- Deterioration of the power factor
- Reduction in the motor power
- Cable, transformer, motor overloads
- Increased noise in the motors
- Recording error in the meters
- Oversizing of the supply capacitance cables
- Contactors not working correctly
- Interference in the electronic systems
- Etc.

Medium and long-term effects:

- Shorter life of motors and transformers
- Deterioration of capacitor banks
- Accelerating ageing of insulation and dielectrics
- Derating of transformers and motors
- Etc.

HARMONIC ORDERS

The FOURIER decomposition (harmonic analysis) of the current consumption of a non-linear receiver shows:

- The fundamental, a sinusoidal term at the 50 Hz mains supply frequency
- The harmonics, sinusoidal terms whose frequencies are multiples of the fundamental frequency

According to the equation:

$$I_{rms} = \sqrt{I_1^2 + \sum_{h=2}^n I_h^2}$$

Σ : sum of all the harmonic currents from harmonic 2 (50 Hz x 2) to the last harmonic order n (50 Hz x n)

These harmonic currents circulate in the source. The harmonic impedances of this source then give rise to harmonic voltages, according to the equation:

$$U_h = Z_h \times I_h$$

The harmonic currents induce most of the harmonic voltages causing the overall harmonic distortion of the supply voltage.

$$V_{rms} = \sqrt{U_1^2 + \sum_{h=2}^n U_h^2}$$

Note: The harmonic distortion of the voltage generated by construction defects in the windings of alternators and transformers is generally negligible

The electricity supply frequencies are 50 Hz or 60 Hz, called the fundamental frequency (f1).
For example: in France f1 = 50 Hz.

Harmonic components have a frequency (fn) which is a multiple of the fundamental frequency (f1).

$$f_n = n \times f_1$$

where n is the harmonic order

The FOURIER decomposition (harmonic analysis) of the current consumption of a non-linear receiver shows:

- The fundamental, a sinusoidal term at the 50 Hz mains supply frequency
- The harmonics, sinusoidal terms whose frequencies are multiples of the fundamental frequency

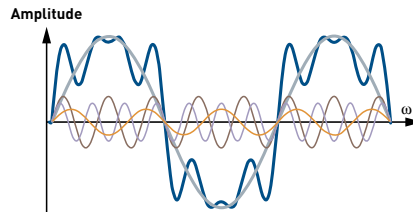

- Resultant.
- Fundamental.
- Order 3: additional current of 150 Hz (3 x 50 Hz).
- Order 5: additional current of 250 Hz (5 x 50 Hz).
- Order 7: additional current of 350 Hz (7 x 50 Hz).
- Etc.
- Order n: additional current of xxx Hz (n x 50 Hz).

SPECIAL CASE OF 3RD ORDER HARMONICS

The main loads generating 3rd order harmonics are single-phase diode rectifiers with capacitive filtering.

Three-phase, non-linear, symmetrical, balanced loads, with no connection to the neutral do not generate any 3rd order harmonics, nor any harmonic orders that are multiples of 3.

Three-phase, non-linear, symmetrical, balanced loads, with connection to the neutral do generate 3rd order harmonic currents and harmonic currents in the neutral conductor in orders that are multiples of 3.
Single-phase loads such as high power lighting (stadium lighting power, for example) also generate 3rd order harmonics.

IMPORTANT: The rms value of the neutral current can be greater than that of the phase current, which on average means that the neutral conductor cross-section must be twice that of the phase conductor cross-section.

- The design of Legrand's isolating transformers with low losses prevents 3rd order harmonics (see Legrand catalogue).
- SAH type – 135 Hz capacitor banks are sized to operate in conditions with high levels of 3rd order harmonics (see page 11).



TOTAL HARMONIC DISTORTION

The total harmonic distortion is used to quantify the distorted global sinusoidal signal using the following theoretical formulas:

individual THD

$$T_n(\%) = \frac{X_n}{X_1} \times 100$$

X_n = rms value of the fundamental (voltages or current)
 X_1 = rms value of the nth harmonic order (voltages or current)

global THD

$$THD-U(\%) = \frac{\sqrt{\sum_{n=2}^n U_n^2}}{U_1} \times 100$$

$$THD-I(\%) = \frac{\sqrt{\sum_{n=2}^n I_n^2}}{I_1} \times 100$$

- Legrand EMDX³ measurement control units provide you with optimum monitoring of your installation, see the Legrand catalogue.
- The "Power Quality" Audit (see page 4) combined with Alpes Technologies' expertise in the field of network analysers allow you to carry out complete diagnostics of the various phenomena in your installation.



IMPACT OF HARMONICS ON CAPACITORS

The capacitor bank reactance is inversely proportional to the frequency, and its ability to cancel out harmonic currents decreases significantly when the frequency increases. This leads to an increase in the current drawn by the capacitors and causes a temperature rise which accelerates capacitor ageing and can even lead to their destruction in extreme cases.

$$Z_c = \frac{1}{C\omega} = \frac{1}{C 2\pi f}$$

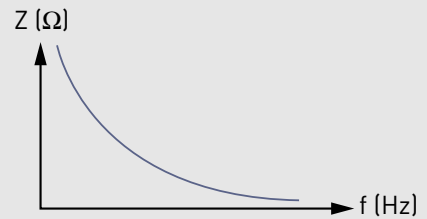

- Alpivar³ capacitors have the capacity to resist harmonics exceeding the requirements of standards IEC 60831-1 & 2
- permissible overvoltage up to 1.18*Un
 - permissible overvoltage up to 2*In

THE PHENOMENON OF RESONANCE

The phenomenon of electrical resonance between the capacitor banks and the electricity supply corresponds to amplification of the existing voltage and current harmonics (increase in the THDu % and THDi %) due to electrical resonance between the capacitor banks and the inductances in the system upstream.

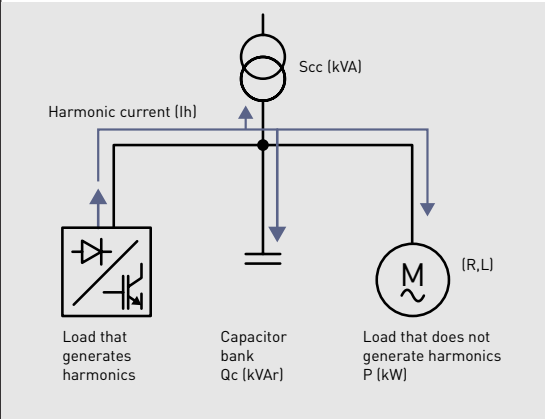

This outline diagram of an electrical installation with capacitor bank and a load that generates harmonics can be drawn as below:

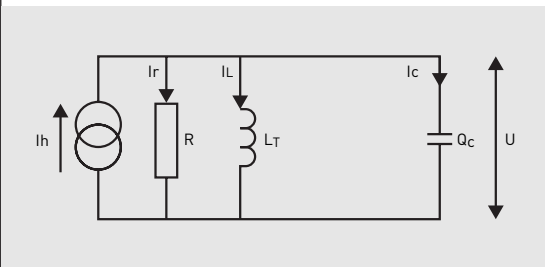

S_{cc} : transformer short-circuit power
 L_T : transformer short-circuit inductance, because the influence of the load inductances and the short-circuit inductance of the distribution network seen from the upstream terminals of an MV/LV transformer is negligible.

Hence the supply impedance seen from the main LV distribution board

$$Z = \frac{1}{\sqrt{\left(\frac{1}{R}\right)^2 + \left(\frac{1}{L_T \omega} - C \omega\right)^2}}$$

$$f_0 = \frac{1}{2\pi \sqrt{L_T C}}$$

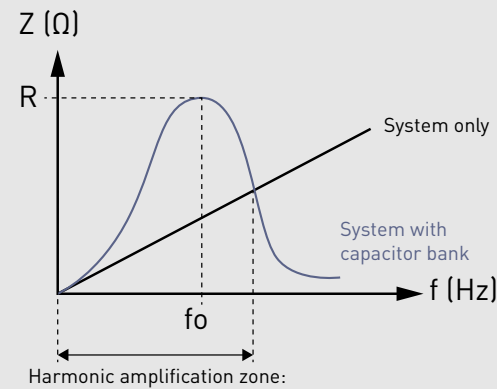

At frequency far, corresponding harmonic currents are generated. Circulating across the various impedances of the installation they generate an increase in the harmonic voltages and therefore in the level of THDu %.

Amplification is seen through the typical curve of impedances in the system as a function of the frequency. It shows the amplified value compared to the initial supply value without capacitors.

At resonance f_0 all the n th order current I_0 generated by the circuit that is causing interference passes into the resistor R , thus meaning that nearly all this current is drawn by loads consuming active power.

The direct consequence of this resonance is an increase in the harmonic voltages, and therefore in the level of THDi.

**ESTIMATE OF PARALLEL RESONANCE BETWEEN THE CAPACITORS AND THE SOURCE**

To find out the harmonic frequency (F_n) of order n with a risk of resonance in the system and the amplification factor (F_a) of the harmonic currents in the capacitors and in the source (transformers), use the formulas below:

$$S_{CC} = \frac{S_T}{U_{CC}}$$

$$F_n = f_1 \times \sqrt{\frac{S_{CC}}{Q_C}} \quad F_a = \frac{\sqrt{S_{CC} \times Q_C}}{S}$$

S_{CC} : transformer short-circuit power
 U_{CC} : MV/LV transformer short-circuit voltage
 Q_C : capacitor bank reactive power
 f_1 : fundamental frequency (50 Hz in France)
 S_T : power in kVA of the MV/LV transformer (or MV/LV transformers where there are two or more transformers in parallel)
 S : active power of loads that do not generate harmonics (non-polluting)

The higher the source short-circuit power (S_{CC}), the further the resonance frequency is from dangerous harmonic frequencies.

The higher the power (P) of non-polluting loads, the lower the harmonic current amplification factor.

EXAMPLE

Transformer power: $S_T = 1000$ kVA where $U_{CC} = 6\%$
 Load power: $S = 750$ kW
 Capacitor bank power: $Q_C = 350$ kVAR
 Thus:

Transformer short-circuit power:

$$S_{CC} = \frac{1000}{6} \times 100 = 16,666 \text{ kVA}$$

Risk of resonance frequency:

$$F_n = 50 \times \sqrt{\frac{16,666}{350}} \text{ Hz} \approx 50 \times 6.90 \text{ Hz} \approx 354 \text{ Hz}$$

Level of amplification of harmonics:

$$F_a = \frac{\sqrt{16,666 \times 350}}{750} \approx 3.22$$

IMPORTANT: In this example, the installation demonstrates a risk of resonance with the 7th order harmonic. To avoid this risk, use a capacitor bank with detuned reactor. See next section.

PROTECTING CAPACITORS USING DETUNED REACTORS

The detuned reactor performs a dual role:

- Increasing the capacitor impedance in relation to the harmonic currents
- Shifting the parallel resonance frequency of the source and the capacitor to below the main frequencies of the harmonic currents that are causing interference

Adding the reactor impedance

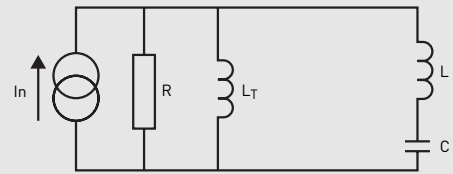

$$f_o = \frac{1}{2\pi\sqrt{(L_T + L)C}} \quad f_r = \frac{1}{2\pi\sqrt{LC}}$$

f_o : Parallel resonance frequency (anti-resonance)
 f_r : Serial resonance frequency for the branch between the capacitors and the detuned reactor

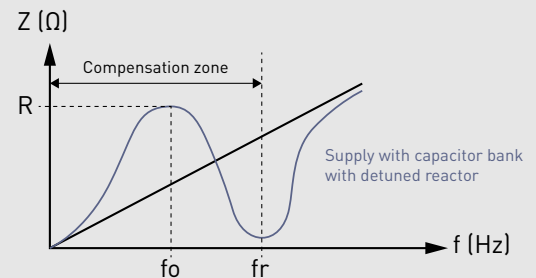

- The detuned reactor and capacitor assembly is capacitive for frequencies below f_r , so allows reactive energy compensation.
- The detuned reactor and capacitor assembly is inductive, so prevents amplification of the harmonics.

NOTE: The serial frequency (f_r) chosen must be less than the first harmonic order present in the circuit.

APPENDICES

PHYSICAL STEPS AND ELECTRICAL STEPS

DEFINITION

Physical steps equivalent to the kVAr powers of the various capacitors which make up an automatic or dynamic capacitor bank (Alpimatic/Alpistatic range) and tripped individually by the contactors.

Electrical steps = total power/smallest physical step and represents the power kVAr seen by the electrical installation.

The design of Alpimatic and Alpistatic racks and the latest generation of Alptec 3.2/5.2/8.2 and Alptec 8 power factor controllers with sophisticated regulation ensures optimal, accurate, fast regulation with the least possible number of capacitors, alternating the steps required as a function of the reactive power needed.

This type of regulation:

- increases the capacitor bank service life
- ensures that all components which make up the capacitor bank steps (capacitors, contactors, etc.) age uniformly and
- allows a smaller enclosure and hence lower purchase and maintenance costs of the enclosure.

EXAMPLE OF AN ALPIMATIC 225 KVAR CAPACITOR BANK

Cat. No.	Capacitor bank power	Physical steps
M22540	225	(25+50)+2x75

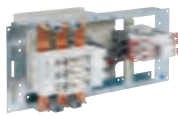

25 kVAr

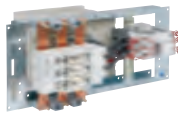

50 kVAr

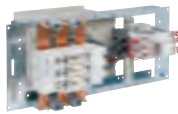

75 kVAr

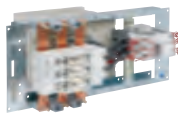

75 kVAr

Number of electrical steps:
225/25 = 9 steps of 25 kVAr

OPERATING CYCLE

Power kVAr	4 PHYSICAL STEPS			
	25	50	75	75
25	1	0	0	0
50	0	1	0	0
75	0	0	1	0
100	1	0	0	1
125	0	1	1	0
150	1	1	0	1
175	1	0	1	1
200	0	1	1	1
225	1	1	1	1

0 = step disconnected
1 = step activated

+ ALPTEC power factor controllers –
Control of capacitor steps, see p. 57





Catalogue number index

Cat.Nos	Page	Pack	Cat.Nos	Page	Pack	Cat.Nos	Page	Pack	Cat.Nos	Page	Pack
ALPES TECHNOLOGIES			BS.RS14440.215	22	1	M45040	24	1	MH2540/DISJ	25	1
			BS.RS21640.215	-	1	M45040/DISJ	-	1	MH25040	-	1
			BS.RS28840.215	-	1	M47.540	-	1	MH25040/DISJ	-	1
ALP			EXT			M47.540/DISJ	-	1	MH27540	-	1
ALPTEC3.2	57	1				M5040	-	1	MH27540/DISJ	-	1
ALPTEC5.2	-	1	EXT2GR	58	1	M5040/DISJ	-	1	MH3040	-	1
ALPTEC8	-	1	EXT3GR	-	1	M50040	-	1	MH3040/DISJ	-	1
ALPTEC8.2	-	1	EXT4GRS	-	1	M50040/DISJ	-	1	MH30040	-	1
B			EXTETH	-	1	M55040	-	1	MH30040/DISJ	-	1
B1040	22	1	EXTHARM	-	1	M55040/DISJ	-	1	MH3540	-	1
B1540	-	1	EXTPROFI	-	1	M6040	-	1	MH3540/DISJ	-	1
B2040	-	1	EXTRS485	-	1	M6040/DISJ	-	1	MH35040	-	1
B2540	-	1	M			M60040	-	1	MH35040/DISJ	-	1
B3040	-	1	M1040	24	1	M60040/DISJ	-	1	MH4040	-	1
B4040	-	1	M1040/DISJ	-	1	M67540	-	1	MH4040/DISJ	-	1
B5040	-	1	M10040	-	1	M67.540	-	1	MH40040	-	1
B6040	-	1	M10040-F	-	1	M67.540/DISJ	-	1	MH40040/DISJ	-	1
B7540	-	1	M10040/DISJ	-	1	M7540	-	1	MH45040	-	1
B9040	-	1	M10040-F/DISJ	-	1	M7540-F	-	1	MH45040/DISJ	-	1
B10040	-	1	M12.540	-	1	M7540/DISJ	-	1	MH47.540	-	1
B12540	-	1	M12.540/DISJ	-	1	M7540-F/DISJ	-	1	MH47.540/DISJ	-	1
B15040	-	1	M112.540	-	1	M75040	-	1	MH5040	-	1
B17540	-	1	M112.540/DISJ	-	1	M82540	-	1	MH5040/DISJ	-	1
BH			M12540	-	1	M87.540	-	1	MH50040	-	1
BH1040	22	1	M12540/DISJ	-	1	M87.540-F	-	1	MH50040/DISJ	-	1
BH1540	-	1	M1540	-	1	M87.540/DISJ	-	1	MH55040	-	1
BH2040	-	1	M1540/DISJ	-	1	M87.540-F/DISJ	-	1	MH55040/DISJ	-	1
BH2540	-	1	M15040	-	1	M90040	-	1	MH6040	-	1
BH3040	-	1	M15040/DISJ	-	1	MH			MH6040/DISJ	-	1
BH4040	-	1	M17540	-	1	MH1040	25	1	MH60040	-	1
BH5040	-	1	M17540/DISJ	-	1	MH1040/DISJ	-	1	MH60040/DISJ	-	1
BH6040	-	1	M2040	-	1	MH10040	-	1	MH67540	-	1
BH7540	-	1	M2040/DISJ	-	1	MH10040-F	-	1	MH67.540	-	1
BH9040	-	1	M20040	-	1	MH10040/DISJ	-	1	MH67.540/DISJ	-	1
BH10040	-	1	M20040/DISJ	-	1	MH10040-F/DISJ	-	1	MH7540	-	1
BH12540	-	1	M22540	-	1	MH12540	-	1	MH7540-F	-	1
BH15040	-	1	M22540/DISJ	-	1	MH12540/DISJ	-	1	MH7540/DISJ	-	1
BH17540	-	1	M2540	-	1	MH12.540	-	1	MH7540-F/DISJ	-	1
BS			M2540/DISJ	-	1	MH12.540/DISJ	-	1	MH75040	-	1
BS5040.189	22	1	M25040	-	1	MH112.540	-	1	MH82540	-	1
BS7540.189	-	1	M25040/DISJ	-	1	MH112.540/DISJ	-	1	MH87.540	-	1
BS10040.189	-	1	M27540	-	1	MH1540	-	1	MH87.540-F	-	1
BS15040.189	-	1	M27540/DISJ	-	1	MH1540/DISJ	-	1	MH87.540/DISJ	-	1
BS20040.189	-	1	M3040	-	1	MH15040	-	1	MH87.540-F/DISJ	-	1
BS25040.189	-	1	M3040/DISJ	-	1	MH15040/DISJ	-	1	MH90040	-	1
BS30040.189	-	1	M30040	-	1	MH17540	-	1	MS		
BS.R			M30040/DISJ	-	1	MH17540/DISJ	-	1	MS10040.189	26	1
BS.R4040.189	22	1	M3540	-	1	MH2040	-	1	MS10040.189/DISJ	-	1
BS.R8040.189	-	1	M3540/DISJ	-	1	MH2040/DISJ	-	1	MS10540.135	-	1
BS.R12040.189	-	1	M35040	-	1	MH20040	-	1	MS10540.135/DISJ	-	1
BS.R16040.189	-	1	M35040/DISJ	-	1	MH20040/DISJ	-	1	MS12540.189	-	1
BS.R20040.189	-	1	M4040	-	1	MH22540	-	1	MS12540.189/DISJ	-	1
BS.R24040.189	-	1	M4040/DISJ	-	1	MH22540/DISJ	-	1	MS14040.135	-	1
BS.R28040.189	-	1	M40040	-	1	MH2540	-	1	MS14040.135/DISJ	-	1
BS.RS7240.215	-	1	M40040/DISJ	-	1						

Cat.Nos	Page	Pack	Cat.Nos	Page	Pack	Cat.Nos	Page	Pack	Cat.Nos	Page	Pack
MS15040.189	26	1	MS8740.135/DISJ	26	1	P7540	54	1	SAH3.45-20.2A	53	1
MS15040.189/DISJ	-	1	MS.R			P252540	-	1	SAH3.52-62.0A	-	1
MS17540.135	-	1	MS.R12040.189	27	1	P255040	-	1	SAH4.05-31.4A	-	1
MS17540.135/DISJ	-	1	MS.R12040.189/DISJ	-	1	PH			SAH4.30-25.1A	-	1
MS20040.189	-	1	MS.R16040.189	-	1	PH12.540	54	1	SAH4.31-16.2A	-	1
MS20040.189/DISJ	-	1	MS.R16040.189/DISJ	-	1	PH12.512.540	-	1	SAH5.36-23.9A	-	1
MS21040.135	-	1	MS.R20040.189	-	1	PH2540	-	1	SAH7.05-31.0A	-	1
MS21040.135/DISJ	-	1	MS.R20040.189/DISJ	-	1	PH5040	-	1	SAH8.10-15.7A	-	1
MS22540.189	-	1	MS.R24040.189	-	1	PH7540	-	1	SAH8.55-12.6A	-	1
MS22540.189/DISJ	-	1	MS.R24040.189/DISJ	-	1	PH252540	-	1	SAH10.70-12.0A	-	1
MS24540.135	-	1	MS.R28040.189	-	1	PH255040	-	1	SAH14.10-16.0A	-	1
MS24540.135/DISJ	-	1	MS.R28040.189/DISJ	-	1	R			STS		
MS25040.189	-	1	MS.R32040.189	-	1	R5.12.540.189	55	1	STS10040.189	31	1
MS25040.189/DISJ	-	1	MS.R32040.189/DISJ	-	1	R5.2540.189	-	1	STS100040.189	-	1
MS27540.189	-	1	MS.R36040.189	-	1	R5.5040.189	-	1	STS10040.189/DISJ	-	1
MS27540.189/DISJ	-	1	MS.R36040.189/DISJ	-	1	R5.R2040.189	-	1	STS112540.189	-	1
MS28040.135	-	1	MS.R40040.189	-	1	R5.R4040.189	-	1	STS125040.189	-	1
MS28040.135/DISJ	-	1	MS.R40040.189/DISJ	-	1	R7.12.540.189	-	1	STS12540.189	-	1
MS30040.189	-	1	MS.R44040.189	-	1	R7.2540.189	-	1	STS12540.189/DISJ	-	1
MS30040.189/DISJ	-	1	MS.R44040.189/DISJ	-	1	R7.5040.189	-	1	STS137540.189	-	1
MS31540.135	-	1	MS.R48040.189	-	1	R7.7540.189	-	1	STS150040.189	-	1
MS31540.135/DISJ	-	1	MS.R48040.189/DISJ	-	1	R7.R2040.189	-	1	STS15040.189	-	1
MS35040.189	-	1	MS.R52040.189	-	1	R7.R4040.189	-	1	STS15040.189/DISJ	-	1
MS35040.189/DISJ	-	1	MS.R52040.189/DISJ	-	1	R7.R8040.189	-	1	STS17540.189	-	1
MS37540.189	-	1	MS.R56040.189	-	1	R9.RS7240.215	-	1	STS17540.189/DISJ	-	1
MS37540.189/DISJ	-	1	MS.R56040.189/DISJ	-	1	RST			STS20040.189	-	1
MS38540.135	-	1	MS.R60040.189	-	1	RST7.2540.189	56	1	STS20040.189/DISJ	-	1
MS38540.135/DISJ	-	1	MS.R60040.189/DISJ	-	1	RST7.5040.189	-	1	STS22540.189	-	1
MS42040.135	-	1	MS.R64040.189	-	1	RST7.7540.189	-	1	STS22540.189/DISJ	-	1
MS42040.135/DISJ	-	1	MS.R72040.189	-	1	RST7.R4040.189	-	1	STS25040.189	-	1
MS45040.189	-	1	MS.R80040.189	-	1	RST7.R8040.189	-	1	STS25040.189/DISJ	-	1
MS45040.189/DISJ	-	1	MS.RS14440.215	-	1	RST9.10040.189	-	1	STS27540.189	-	1
MS45540.135	-	1	MS.RS14440.215/DISJ	-	1	RST9.12540.189	-	1	STS27540.189/DISJ	-	1
MS45540.135/DISJ	-	1	MS.RS21640.215	-	1	RST9.R12040.189	-	1	STS30040.189	-	1
MS49040.135	-	1	MS.RS21640.215/DISJ	-	1	RST9.RS7240.215	-	1	STS30040.189/DISJ	-	1
MS49040.135/DISJ	-	1	MS.RS28840.215	-	1	SAH			STS35040.189	-	1
MS5240.135	-	1	MS.RS28840.215/DISJ	-	1	SAH0.43-161.6A	53	1	STS35040.189/DISJ	-	1
MS5240.135/DISJ	-	1	MS.RS36040.215	-	1	SAH0.45-150.0A	-	1	STS40040.189	-	1
MS52540.135	-	1	MS.RS36040.215/DISJ	-	1	SAH0.48-123.0A	-	1	STS40040.189/DISJ	-	1
MS52540.135/DISJ	-	1	MS.RS43240.215	-	1	SAH0.58-121.2A	-	1	STS45040.189	-	1
MS52540.189	-	1	MS.RS43240.215/DISJ	-	1	SAH0.72-83.0A	-	1	STS45040.189/DISJ	-	1
MS52540.189/DISJ	-	1	MS.RS50440.215	-	1	SAH0.86-80.8A	-	1	STS50040.189	-	1
MS56040.135	-	1	MS.RS50440.215/DISJ	-	1	SAH0.90-75.0A	-	1	STS50040.189/DISJ	-	1
MS56040.135/DISJ	-	1	MS.RS57640.215	-	1	SAH1.00-125.6A	-	1	STS52540.189	-	1
MS60040.189	-	1	MS.RS57640.215/DISJ	-	1	SAH1.34-87.0A	-	1	STS52540.189/DISJ	-	1
MS60040.189/DISJ	-	1	MS.RS64840.215	-	1	SAH1.35-94.2A	-	1	STS57540.189	-	1
MS63040.135	-	1	MS.RS72040.215	-	1	SAH1.44-74.4A	-	1	STS57540.189/DISJ	-	1
MS67540.189	-	1	MS.RS79240.215	-	1	SAH1.45-42.0A	-	1	STS62540.189	-	1
MS7040.135	-	1	MS.RS86440.215	-	1	SAH1.73-40.4A	-	1	STS62540.189/DISJ	-	1
MS7040.135/DISJ	-	1	P			SAH1.78-38.0A	-	1	STS70040.189	-	1
MS75040.189	-	1	P12.540	54	1	SAH2.02-62.8A	-	1	STS70040.189/DISJ	-	1
MS7540.189	-	1	P12.512.540	-	1	SAH2.15-50.0A	-	1	STS75040.189	-	1
MS7540.189/DISJ	-	1	P2540	-	1	SAH2.68-44.0A	-	1	STS82540.189	-	1
MS8740.135	-	1	P5040	-	1	SAH2.85-21.0A	-	1	STS87540.189	-	1



Cat.Nos	Page	Pack	Cat.Nos	Page	Pack	Cat.Nos	Page	Pack	Cat.Nos	Page	Pack
STS95040.189	31	1	STS.RS86440.215	32	1	V1544CB	37	1	V4040	38	1
STS.R			SUPP			V1544-3MONO	-	1	V4040CB	-	1
STS.R108040.189	32	1	SUPP/ALPIBLOC	22	1	V2.523	36	1	V4040-3MONO	-	1
STS.R12040.189	-	1	V			V2.523CB	-	1	V4044	37	1
STS.R12040.189/DISJ	-	1	V1023	36	1	V2.523-3MONO	-	1	V4044CB	-	1
STS.R120040.189	-	1	V1023CB	-	1	V2.540	38	1	V4044-3MONO	-	1
STS.R132040.189	-	1	V1023-3MONO	-	1	V2.540CB	-	1	V4052	-	1
STS.R144040.189	-	1	V1040	38	1	V2.540-3MONO	-	1	V4052CB	-	1
STS.R16040.189	-	1	V1040CB	-	1	V2023	36	1	V4052-3MONO	-	1
STS.R16040.189/DISJ	-	1	V1040-3MONO	-	1	V2023CB	-	1	V4069	-	1
STS.R20040.189	-	1	V10040	38	1	V2023-3MONO	-	1	V4069CB	-	1
STS.R20040.189/DISJ	-	1	V10040CB	-	1	V2040	38	1	V5023	36	1
STS.R24040.189	-	1	V10040-3MONO	-	1	V2040CB	-	1	V5023CB	-	1
STS.R24040.189/DISJ	-	1	V10044	37	1	V2040-3MONO	-	1	V5023-3MONO	-	1
STS.R28040.189	-	1	V10044CB	-	1	V2044	37	1	V5040	38	1
STS.R28040.189/DISJ	-	1	V10044-3MONO	-	1	V2044CB	-	1	V5040CB	-	1
STS.R32040.189	-	1	V1052	37	1	V2044-3MONO	-	1	V5040-3MONO	-	1
STS.R32040.189/DISJ	-	1	V1052CB	-	1	V2052	-	1	V5044	37	1
STS.R36040.189	-	1	V1052-3MONO	-	1	V2052CB	-	1	V5044CB	-	1
STS.R36040.189/DISJ	-	1	V10052	-	1	V2052-3MONO	-	1	V5044-3MONO	-	1
STS.R40040.189	-	1	V10052CB	-	1	V2069	-	1	V5052	-	1
STS.R40040.189/DISJ	-	1	V10052-3MONO	-	1	V2069CB	-	1	V5052CB	-	1
STS.R44040.189	-	1	V1069	-	1	V2523	36	1	V5052-3MONO	-	1
STS.R44040.189/DISJ	-	1	V1069CB	-	1	V2523CB	-	1	V5069	-	1
STS.R48040.189	-	1	V10069	-	1	V2523-3MONO	-	1	V5069CB	-	1
STS.R48040.189/DISJ	-	1	V10069CB	-	1	V2540	38	1	V523	36	1
STS.R52040.189	-	1	V12.540	38	1	V2540CB	-	1	V523CB	-	1
STS.R52040.189/DISJ	-	1	V12.540CB	-	1	V2540-3MONO	-	1	V523-3MONO	-	1
STS.R56040.189	-	1	V12.540-3MONO	-	1	V2544	37	1	V540	38	1
STS.R56040.189/DISJ	-	1	V12.544	37	1	V2544CB	-	1	V540CB	-	1
STS.R60040.189	-	1	V12.544CB	-	1	V2544-3MONO	-	1	V540-3MONO	-	1
STS.R60040.189/DISJ	-	1	V12.544-3MONO	-	1	V2552	-	1	V544	37	1
STS.R68040.189	-	1	V12.552	-	1	V2552CB	-	1	V544CB	-	1
STS.R68040.189/DISJ	-	1	V12.552CB	-	1	V2552-3MONO	-	1	V544-3MONO	-	1
STS.R72040.189	-	1	V12.552-3MONO	-	1	V3023	36	1	V6.2540	38	1
STS.R80040.189	-	1	V12044	-	1	V3023CB	-	1	V6.2540CB	-	1
STS.R84040.189	-	1	V12044CB	-	1	V3023-3MONO	-	1	V6.2540-3MONO	-	1
STS.R92040.189	-	1	V12044-3MONO	-	1	V3040	38	1	V6.2544	37	1
STS.R96040.189	-	1	V12540	38	1	V3040CB	-	1	V6.2544CB	-	1
STS.RS			V12540CB	-	1	V3040-3MONO	-	1	V6.2544-3MONO	-	1
STS.RS14440.215	32	1	V12540-3MONO	-	1	V3044	37	1	V6023	36	1
STS.RS14440.215/DISJ	-	1	V12544	37	1	V3044CB	-	1	V6023CB	-	1
STS.RS21640.215	-	1	V12544CB	-	1	V3044-3MONO	-	1	V6023-3MONO	-	1
STS.RS21640.215/DISJ	-	1	V12544-3MONO	-	1	V3052	-	1	V6040	38	1
STS.RS28840.215	-	1	V12552	-	1	V3052CB	-	1	V6040CB	-	1
STS.RS28840.215/DISJ	-	1	V12552CB	-	1	V3052-3MONO	-	1	V6040-3MONO	-	1
STS.RS36040.215	-	1	V12552-3MONO	-	1	V3069	-	1	V6044	37	1
STS.RS36040.215/DISJ	-	1	V15044	-	1	V3069CB	-	1	V6044CB	-	1
STS.RS43240.215	-	1	V15044CB	-	1	V344	-	1	V6044-3MONO	-	1
STS.RS43240.215/DISJ	-	1	V15044-3MONO	-	1	V344CB	-	1	V6052	-	1
STS.RS50440.215	-	1	V1523	36	1	V344-3MONO	-	1	V6052CB	-	1
STS.RS50440.215/DISJ	-	1	V1523CB	-	1	V3540	38	1	V6052-3MONO	-	1
STS.RS57640.215	-	1	V1523-3MONO	-	1	V3540CB	-	1	V6069	-	1
STS.RS57640.215/DISJ	-	1	V1540	38	1	V3540-3MONO	-	1	V6069CB	-	1
STS.RS64840.215	-	1	V1540CB	-	1	V4023	36	1	V7.540	38	1
STS.RS72040.215	-	1	V1540-3MONO	-	1	V4023CB	-	1	V7.540CB	-	1
STS.RS79240.215	-	1	V1544	37	1	V4023-3MONO	-	1	V7.540-3MONO	-	1

Cat.Nos	Page	Pack	Cat.Nos	Page	Pack	Cat.Nos	Page	Pack	Cat.Nos	Page	Pack
V7.544	37	1	VH1540-3MONO	38	1	4 151 61	45	1	4 202 00		
V7.544CB	-	1	VH2.540	-	1	4 151 62	-	1	4 202 08	35	1
V7.544-3MONO	-	1	VH2.540CB	-	1	4 151 63	-	1	4 202 09	-	1
V7044	-	1	VH2.540-3MONO	-	1	4 151 64	-	1	4 202 38	-	1
V7044CB	-	1	VH2040	-	1	4 151 65	-	1	4 202 39	-	1
V7044-3MONO	-	1	VH2040CB	-	1	4 151 66	-	1	4 202 68	-	1
V7052	-	1	VH2040-3MONO	-	1	4 151 67	-	1	4 202 69	-	1
V7052CB	-	1	VH2540	-	1	4 151 68	-	1	4 206 00		
V7052-3MONO	-	1	VH2540CB	-	1	4 151 69	-	1	4 206 08	35	1
V7069	-	1	VH2540-3MONO	-	1	4 151 70	-	1	4 206 09	-	1
V7069CB	-	1	VH3040	-	1	4 151 71	-	1	4 220 00		
V7540	38	1	VH3040CB	-	1	4 151 72	-	1	4 220 01	35	1
V7540CB	-	1	VH3040-3MONO	-	1	4 151 73	-	1	4 220 02	-	1
V7540-3MONO	-	1	VH3540	-	1	4 151 74	-	1	4 220 03	-	1
V7544	37	1	VH3540CB	-	1	4 151 75	-	1	4 220 04	-	1
V7544CB	-	1	VH3540-3MONO	-	1	4 151 76	-	1	4 220 29	-	1
V7544-3MONO	-	1	VH4040	-	1	4 151 77	-	1	4 220 30	-	1
V8040	38	1	VH4040CB	-	1	4 151 78	-	1	4 220 31	-	1
V8040CB	-	1	VH4040-3MONO	-	1	4 151 79	-	1	4 220 32	-	1
V8040-3MONO	-	1	VH540	-	1	4 151 80	-	1	4 220 43	-	1
V8044	37	1	VH540-3MONO	-	1	4 151 81	-	1	4 220 44	-	1
V8044CB	-	1	VH540CB	-	1	4 151 82	-	1	4 220 45	-	1
V8044-3MONO	-	1	VH5040	-	1	4 151 83	-	1	4 220 46	-	1
V8052	-	1	VH5040CB	-	1	4 151 84	-	1	4 222 00		
V8052CB	-	1	VH5040-3MONO	-	1	4 151 85	-	1	4 222 64	35	1
V8052-3MONO	-	1	VH6.2540	-	1	4 151 86	-	1	4 222 65	-	1
V8069	-	1	VH6.2540CB	-	1	4 151 87	-	1	4 222 66	-	1
V8069CB	-	1	VH6.2540-3MONO	-	1	4 151 88	-	1	4 222 76	-	1
V8552	-	1	VH6040	-	1	4 151 89	-	1	4 222 77	-	1
V8552CB	-	1	VH6040CB	-	1	4 151 90	-	1	4 222 78	-	1
V8552-3MONO	-	1	VH6040-3MONO	-	1	4 151 91	-	1	4 226 00		
V9040	38	1	VH7.540	-	1	4 151 92	-	1	4 226 87	58	1
V9040CB	-	1	VH7.540CB	-	1	4 151 93	-	1	4 226 88	-	1
V9040-3MONO	-	1	VH7.540-3MONO	-	1	4 151 94	-	1			
V9044	37	1	VH7540	-	1	4 200 00					
V9044CB	-	1	VH7540CB	-	1	4 200 41	35	1			
V9044-3MONO	-	1	VH7540-3MONO	-	1	4 200 42	-	1			
V9052	-	1	VH8040	-	1	4 200 43	-	1			
V9052CB	-	1	VH8040CB	-	1	4 200 44	-	1			
V9052-3MONO	-	1	VH8040-3MONO	-	1	4 200 45	-	1			
V9069	-	1	VH9040	-	1	4 200 46	-	1			
V9069CB	-	1	VH9040CB	-	1	4 200 47	-	1			
VH			VH9040-3MONO	-	1	4 200 81	-	1			
VH1040	38	1				4 200 82	-	1			
VH1040CB	-	1	LEGRAND			4 200 83	-	1			
VH1040-3MONO	-	1	4 121 00			4 200 84	-	1			
VH12.540	-	1	4 121 62	58	1	4 200 85	-	1			
VH12.540CB	-	1	4 121 63	-	1	4 200 86	-	1			
VH12.540-3MONO	-	1	4 121 64	-	1	4 200 87	-	1			
VH10040	-	1	4 121 65	-	1	4 201 00					
VH10040CB	-	1	4 121 66	-	1	4 201 21	35	1			
VH10040-3MONO	-	1	4 121 67	-	1	4 201 22	-	1			
VH12540	-	1	4 121 68	-	1	4 201 23	-	1			
VH12540CB	-	1	4 121 69	-	1	4 201 24	-	1			
VH12540-3MONO	-	1	4 151 00			4 201 25	-	1			
VH1540	-	1	4 151 60	45	1	4 201 26	-	1			
VH1540CB	-	1				4 201 27	-	1			

SALES CONDITIONS

See our current tariffs and price lists

The information given in this catalogue (technical characteristics, dimensions, diagrams, photos) may be amended.

They therefore imply no commitment on our part.



FOLLOW
US ON

@ [alpestechnologies.com](https://www.alpestechnologies.com)

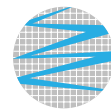

ALPES TECHNOLOGIES

P.A.E. Les Glaisins
7, rue des Bouvières - B.P. 332
74943 Annecy-Le-Vieux Cedex
Tel: +33(0)4 50 64 05 13
Fax: +33(0)4 50 64 04 37
E-mail: com@alpestechnologies.com